

Historical Museum Permanent Memorial to Past



WAYNE COUNTY'S Historical Museum, in Wayne, stands as a permanent reminder and home for many displays and antiques depicting the history of the county. Several improvements have taken place at the museum, which is located at 702 Lincoln St., and many of the relics are placed in authentic surroundings.

By LAYON BECKMAN
It's been nearly two years since the family of the late Reille Lay turned over the family home in Wayne to the County Historical Society to use as a permanent housing for museum pieces collected during the years.

Since then, many changes have occurred both in and around the museum, which is located at 702 Lincoln St.

The house recently received a thorough cleaning by the Confusible Collectables Cleaners Club of Wayne. Grounds around the house are kept attractive looking with the help of David and Doug Doeschers, sons of Mr. and Mrs. Darrell Doeschers.

The museum was opened for a while recently to do some remodeling in preparation for a grand opening late this summer or in early fall.

Tours, however, are once again being given each Sunday afternoon from 2 to 4 p.m. and each Thursday evening from 7 to 9 p.m. Special tours for groups can be arranged with the curator, Mrs. Clifford Johnson.

Hosts at the museum tonight (Thursday) are Mr. and Mrs. Kenneth Olds and Kay Cattie, Mr. and Mrs. Leo Jensen and Mrs. Gordon Nedergaard will greet visitors to the museum on Sunday, June 18.

Three hosts are always on duty as greeters and guides, and Mrs. Johnson says she plans to train five to 10 members of the Historical Society more extensively. A brochure of the history and general information about the

museum will soon be printed to distribute to visitors.

Improvements which have taken place at the museum in the last year include a display of horse equipment along one wall in the basement. The wall was built to resemble the side of a barn and houses old harnesses, saddles, bridles, fly nets and other horse paraphernalia.

Small farm machinery, much of it hand operated, is arranged in two rooms.

A small basement kitchen for laundry and canning supplements the main kitchen on the first floor.

Floors of inlaid design decorate each of the main rooms on the first floor of the museum. The entire entry is paneled in wood, and all of the light fixtures are original.

Three of the five fireplaces in the home are located on the first floor. A china cabinet in the dining room nearly extends the length of the entire wall. Several old musical instruments add interest to the front parlor.

Two stairways lead to the second floor, which houses four bedrooms and a maid's room. Ample windows and a fireplace in one bedroom make it suitable for an upstairs sitting room. Other rooms contain venerated souvenirs of early Nebraska territorial days, and a sleeping porch now holds many American Indian artifacts.

The most extensive work in the museum has been done on the third floor (attic), where several glass-fronted wardrobes have been secured to the

walls. During June, old wedding dresses, hats, shoes, and men's suits are being displayed on forms.

Old sewing machines and other apparatus also are located on the third floor, as well as displays of old photographic relics. Also serving as conversation pieces are the windows, in wall-fitting patterns.

The Elkhorn Valley Iris Society has provided flower arrangements for the museum's library this spring. Mrs. William Hagerman has used irises from the gardens of Lucile Larson, Jim Hummel and Roger Nelson.

The Historical Society is in the process of erecting a flag pole and sign at the museum.

The Society recently sponsored a Table Fashions on Parade show at the city auditorium, which realized nearly \$140 to help with improvements at the museum site.

All Wayne County Clubs were invited to provide table settings for the show, which took place in April. Thirty-two organizations responded with displays ranging from an outdoor cookout to a child's tiny tea party and oriental table settings.

Focal point of the show was the museum dining room table and chairs, which displayed old china, silverware, glassware, linens and an ornate lamp. The Wayne Federated Woman's Club was in charge of a tea table and served coffee, tea and cookies to the visitors.

The Historical Society plans to make the Table Fashions on Parade show an

annual affair.

Besides the new museum, the Historical Society takes an active interest in the old LaPorte Cemetery, which is located two miles south and three and a fourth miles east of Wayne.

LaPorte was the original site of the town, before the railroad's arrival made it necessary to move the town to its present location at Wayne.

Each spring the Society encourages a youth group to clean the old cemetery. This year the Teen Supremes 4-H Club went about the task. On Memorial Day, the American Legion conducts simple services there. Rain, however, curtailed the activities this year. Adolph Korn, a neighbor who resides near the cemetery, has hung the American flag in the cemetery on all military holidays for the past several years.

Without doubt, the Wayne County Historical Society plays a vital role in preserving the history of the county.

New officers of the organization are Cletus Sharer, president; Willis Johnson, vice president; Mrs. Allen Shufelt, secretary, and Leon Meyer, treasurer. Other members of the board are Mrs. Joe Claybaugh, Mrs. Terry Bartling and Wayne Gilliland.

The Society plans to have a get-acquainted coffee for the Wayne Chamber of Commerce soon and hopes to continue the plan with other organizations.

160 Attend Open House For Herman Hirscherts at Laurel



About 160 friends and relatives attended an open house reception at the Laurel City auditorium Sunday afternoon to observe the golden wedding anniversary of Mr. and Mrs. Herman Hirschert of Laurel.

Lillian Cross and Herman Hirschert were married at Sioux City on April 28, 1928, and have resided in the Laurel, Hartington and Beldens areas.

Their children are Carol Hirschert of Dixon, Mrs. Donald (Bonnie) Knoell of Plattsmouth and Dick Hirschert of South Sioux City. There are 11 grandchildren and six great grandchildren.

Scott Hirschert of South Sioux City registered the guests, who attended from Stayton and Litchfield, Minn.; Lake View, S.D.; Rock Valley, Iowa and Hampton, Ia.; South Sioux City, Lincoln, Hartington, Wayne, Wakefield, York, Grand Island, Omaha, Walthill, Plattsmouth, Norfolk, Dixon, Laurel and Allen.

Gifts, arranged by Mr. and Mrs. Donald Knoell Jr. of Hampton, Ia., were carried by Shelly Hirschert of South Sioux City.

Carol Hirschert was mistress of ceremonies for the afternoon program. Family members were introduced, including Mrs. Hirschert's six brothers and sisters, who were all present for the occasion. The Rev. Kenneth Marquardt spoke briefly.

The cake, which was baked by Frieda Swanson of Laurel, was cut and served by Mrs. Donald Knoell of Plattsmouth and Mrs. Dick Hirschert of South Sioux City.

Vicki Hirschert of South Sioux City and Sandi Knoell of Dixon poured. Punch was served by Randy Knoell of Plattsmouth and Sandi Hirschert.

Assisting in the kitchen were Mrs. Bert Lute, Mrs. Virgil Lühr, Mrs. Morris Kvols, Mrs. Hazel Bruggeman, Mrs. William Mohr, Mrs. Elmer Lyons, Mrs. Harry Samuelson and Mrs. Luella Smith.

The Hirschert family attended worship service together Sunday morning at the United Lutheran Church in Laurel. Afterward, a dinner for 80 relatives and friends was served at the fellowship hall.

Helping in the kitchen for the dinner were Mrs. Gustie Loeb, Mrs. Darrell Dahl, Mrs. Knud Jensen, Lillie Twiford, Mrs. Terry Graf and Mrs. Donald Bartels.

Two Graduating

Two Wayne girls are among 109 women who started to graduate this Friday from Nebraska Methodist Hospital's School of Nursing in Omaha.

Beth Baier and Sherry McClain, both of Wayne, will receive their diplomas during the 84th annual commencement exercises at 8 p.m. at the Orpheum Theatre.

Their parents are Mr. and Mrs. Gilbert Baier and Mr. and Mrs. Tom McClain.

The graduating class will hear Bishop Mark Bryan, bishop for the Nebraska area, United Methodist Church.

Baccalaureate services will be held Friday at 1 p.m. at the First United Methodist Church, 60th and Cass St. Following the service, a dinner for 80 relatives and faculty will sponsor a tea at the hospital's Indian Hills Educational Center, 8501 W. Dodge Rd., in honor of the graduates and their families.



BETH BAIER



SHERRY MCCLAIN

Dance Sunday

The Town Twirlers Square Dance Club will hold its second dance in June Sunday at the Laurel city auditorium, beginning at 8:30 p.m.

Bob Johnson will be the square dance caller.

May Vows Exchanged

LeANN LUBBERSTEDT, daughter of Mr. and Mrs. Larry Lubberstedt of Dixon, and Jere Schroeder, son of Mr. and Mrs. Kenneth Schroeder of Wakefield, were married at Grace Lutheran Church in Wayne on May 20. They are living at 612 E. 18th St., in South Sioux City. The bride is assistant manager at Denning Florist in Sioux City, and the bridegroom is employed at Iowa Beer Processors.

Mark, Marsha, Mike, Sarah Joy and I along with Bob's family and mine do thank you for cards, gifts, visits and flowers during Bob's illness and at the loss of him. Special Thanks To: Dr. Coe Wakefield Health Care Center Personnel Rev. Kenneth Edmonds Carroll Legion Post Methodist Church workers All your loving thoughts and kindly deeds We can not really measure But what you've done for and in memory of Bob We'll truly ever treasure. Pat Johnson

To Marry

The engagement and approaching marriage of Peggy Taylor to Doug Kluever has been announced by the bride-elect's parents, Mr. and Mrs. Dale Taylor Sr. of Allen.

The bride is a 1977 graduate of Allen High School. The bridegroom, who is the son of Mr. and Mrs. Donald Kluever Sr., also of Allen, graduated from Western Iowa Tech in 1977.

Plans are underway for a July 29 wedding at the First Lutheran Church in Allen.

June Meeting Marks Club's Anniversary

The June meeting of the Logan Homemakers' Club was held Monday in the home of Mrs. Reuben Meyer to celebrate the club's 25th anniversary.

A potluck supper was held. Charter members of the organization include Mrs. Harvey Echtenkamp, Mrs. Ben Hollman and Mrs. Reuben Meyer.

Pitch furnished entertainment and prizes went to Mrs. Laverne Wischnof, Mrs. Elenora Heilhold, Mrs. Wilbur Nolte, Mrs. Ron Penlerick, Reuben Meyer and Ben Hollman.

Next regular meeting of the club will be in the fall. The club will meet Sept. 7 at a Wayne park for guest day.

Former Pastor Retires

The Rev. Eugene Golay, a former pastor of the First United Methodist Church of Wayne, will retire June 30 after serving for 46 years in the ministry.

Pastor Golay received his first appointment to a church in Nebraska. Conference shortly after his graduation from college.

Later, he attended Drew Theological Seminary in Madison, N.J., where he finished his Master of Divinity Degree. During those years he served as a pastor of a student charge.

He returned to Nebraska and served the Methodist Church in Wayne from June—1948 until September 1950. At that time he was appointed to the staff of the National Board of Evangelism in Nashville, Tenn. He held that position for six years.

Since then he has served churches in Phoenix, Ariz., Glendale, Calif., and for the past five years at the First United Methodist Church of Orange, Calif.

Pastor and Mrs. Golay will live in Glendale, Calif., after retirement.

READ AND USE WAYNE HERALD WANT-ADS

Gives that Say
IT'S HIS DAY...JUNE 18

Give Your Number One Man...
A Lasting Gift Of Love!

Choose From:

- ★ DIAMOND RINGS
- ★ MONEY CLIPS
- ★ TIE TACKS
- ★ BILLFOLDS
- ★ WATCHES
- ★ RINGS
- ★ POCKET WATCHES

The Diamond Center
(Formerly Dale's Jewelry)

211 Main Wayne 375-1804

THE WAYNE HERALD
Serving Northeast Nebraska's Great Farming Area

No. 89 Thursday, June 15, 1978

PRIZE WINNING NEWSPAPER—1978

114 Main Street Wayne, Nebraska 68787 Phone 375-2600

Established in 1875; a newspaper published semi-weekly, Monday and Thursday (except holidays), by Wayne Herald Publishing Company, Inc., J. Alan Cramer, President; entered in the post office at Wayne, Nebraska 68787. 2nd class postage paid at Wayne, Nebraska 68787.

NATIONAL NEWSPAPER CIRCULATION YEAR 1969
58,794

Chuck Barnes Editor
Jim Marsh Business Manager

Official Newspaper of the City of Wayne, the County of Wayne and the State of Nebraska

SUBSCRIPTION RATES
In Wayne, Pierce, Cedar, Dixon, Thurston, Cumming, Stanton and Madison Counties: \$8.75 per year, \$6.58 for six months, \$4.86 for three months. Outside counties mentioned: \$10.00 per year, \$8.00 for six months, \$6.75 for three months. Single copies 15 cents.

A No-Risk Investment

Receive a High Yield and Insured Safety on Your Savings.

We have a Savings Plan to Fit Your Needs.
Choose a Plan — Then Watch Your Money Grow.

(Federal regulations require substantial interest penalty for early withdrawals from Certificates)

Your Future Is Our Concern Today

ESLIC WAYNE FEDERAL
Savings and Loan

321 Main Street Phone 375-2043

Serving Wayne & Its Surrounding Area Continuously Since 1935

DRIVE-IN THEATRE

NOW THRU TUESDAY
2 COMEDY HITS!!

"Obviously we did something wrong"

JOAN RIVERS
RABBIT TEST

FRI-SUN. LATE SHOW

"COLD TURKEY"

KIDS (Under 12) FREE!

Gay Theatre

Wed. Thurs.—Fri.—Sat.
7:20 & 9:35

JULIA

Sun.—Mon.—Tues.
7:30 & 9:35 p.m.

The Turning Point

WOMEN'S CLUBS

THURSDAY, JUNE 15
Happy Homemakers Home Extension Club tours Milton G. Waldbaum Co.
St. Paul's Naomi Circle, Mrs. Vera Peterson
Immanuel Lutheran Ladies Aid, 2 p.m.

FRIDAY, JUNE 16
St. Paul's Esther Circle, Mrs. Otto Baler
Senior Citizens Center sermonette and sing-a-long, 2 p.m.

SATURDAY, JUNE 17
Pleasant Valley Club, Mrs. Merlin Preston, 2 p.m.

MONDAY, JUNE 19
Three M's Home Extension Club family picnic, Bressler Park, 7 p.m.

TUESDAY, JUNE 20
WWI Auxiliary, Vets Club, 7:30 p.m.

WEDNESDAY, JUNE 21
Hillside Club brunch, Bressler Park, 9:30 a.m.
LaPorte Club, Mrs. John Luschen, 2 p.m.
Villa Wayne Tenants Club weekly meeting, 2 p.m.
Senior Citizens Center current event session, 2 p.m.

THURSDAY, JUNE 22
Villa Wayne Bible study, 10 a.m.
Senior Citizens Center potluck luncheon, noon
Club 15 tour to Bancroft
Just Us Gals Club, Mrs. Douglas Spahr, 2 p.m.
United Presbyterian Women, 2 p.m.
Tops Club, West Elementary School, 7 p.m.

IT'S YOUR CHOICE . . .

Skilled hair stylists from coast-to-coast once made the decision to attend the COLLEGE OF HAIR DESIGN in Lincoln.

The Barbering and Cosmetology School . . . call (402) 474-4244 Collect!!

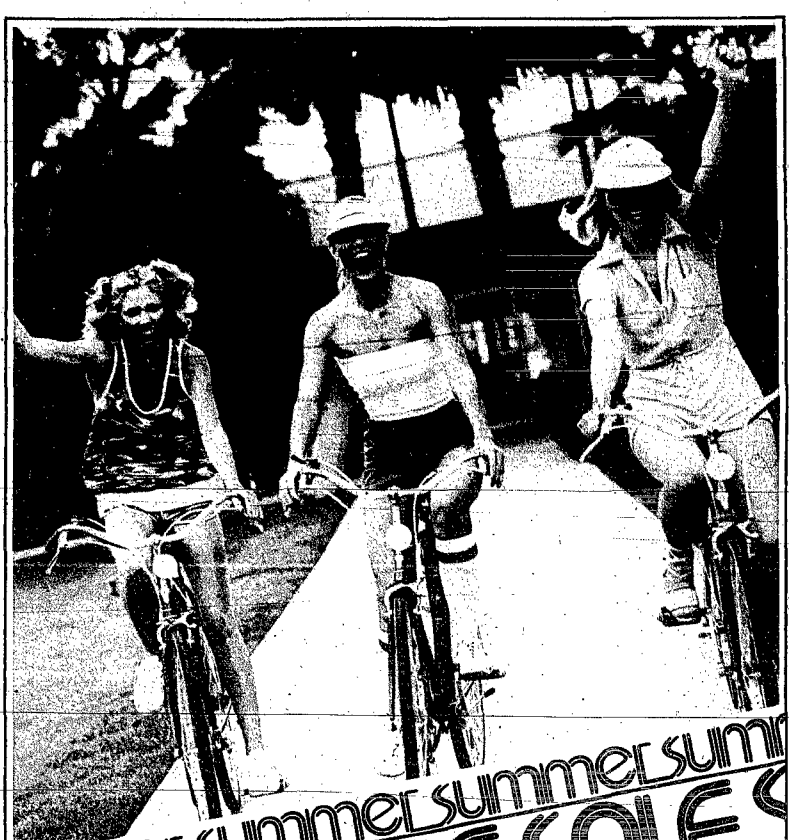

Summer Sales
Summer Sales
Summer Sales

Today is Discount Day at McDonald's
(20% Off. All Sale Merchandise)

It's McDonald's Once a Summer 3-Day Sale! We're Making Room For Our New Fall Merchandise By Marking Down Items Throughout The Entire Store! There's Savings Galore So Hurry!

McDonald's

It All Happens Thur.-Fri.-Sat., June 15-16-17

Rack After Rack of "Yellow Tagged" Spring and Summer Merchandise,
Marked Down Up To 35% Off!

THUR.-FRI.-SAT. (June 15-16-17) ONLY!!

You Get the Mark Down Price

PLUS - 20% OFF THE MARK DOWN PRICE!

(DON'T MISS THIS "YELLOW TAG" SALE! 3-DAYS ONLY!)

K.R. Mitchells Marking Golden Year

Mr. and Mrs. K.R. Mitchell of Allen will celebrate their golden wedding anniversary on Sunday, June 25 during an open house reception at the United Methodist Church in Allen.

All friends and relatives are invited to attend the event from 2 to 4 p.m. No program is being planned. The couple requests no gifts.

Hosting the event are their children and families, Mr. and Mrs. Richard Mitchell of Omaha, Lt. Cmdr. and Mrs. William Mitchell of Oak Harbor, Wash., and Mr. and Mrs. Raymond Pearson of Clemmons, N.C.

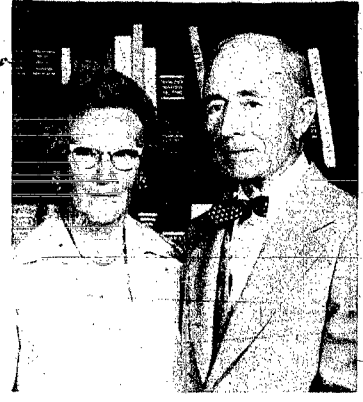

Fete For Newlyweds

A reception and potluck supper will be held at the United Methodist Church in Allen on Monday, June 19, to honor Mr. and Mrs. Harold Snyder, who will be married this Saturday at Haviland, Kan.

Snyder is the son of Mr. and Mrs. Vernon Snyder of Greenleaf, Idaho and the grandson of Mrs. Elsie Snyder of Allen.

All friends and relatives are invited to attend the reception Monday night at 6:30 p.m. Among those planning to attend are the bridegroom's parents and Mr. and Mrs. Merlin Roberts and daughters and Mr. and Mrs. Dan Snyder and sons of Greenleaf.

Jensen-Nobbe Exchange Vows In June 3 Double Ring Rites

Honor attendants at the June 3 wedding of Debra Jensen and Alan Nobbe were the bride's sister, Sharon Freeman of Bellevue, and Mark Martindale of Laurel.

Bridesmaids were Kristy Peterson of Concord and Linda Jensen of Wayne, and groomsmen were the bridegroom's brothers, Gary Nobbe of Sioux City and Larry Nobbe of Allen. Mrs. Mark Martindale was the bride's personal attendant.

The 2 o'clock ceremony took place at St. Mary's Catholic Church in Laurel. Baskets of multicolored flowers and a unity candle decorated the altar of the church for the double ring ceremony.

The bride is the daughter of Mr. and Mrs. Norman Jensen of Dixon. Parents of the bride groom are Mr. and Mrs. Wilfred Nobbe of Concord.

The Rev. Michael Kelly of Laurel officiated. The bride's aunt, Sister Kathleen Garvin of Lincoln, sang "The Wedding Song," "You Light Up My Life," "Follow Me" and "On This Day." Organist was Sister Imelda Koch of Kansas City. Mr. Rob Freeman of Bellevue played the guitar.

Tim Garvin of Dixon was le-

tor at the mass. Altar boy was Tommy Garvin of North Platte. Flower girl was Heather Nobbe of Sioux City, and ring bearers were Jason Freeman of Bellevue and Danny Jensen of Wayne.

Guests were ushered into the church by Monte Jensen of Wayne and Rob Freeman of Bellevue. The guests were registered by Mrs. Tom Garvin of North Platte. Mrs. Gary Nobbe and Mrs. Dave Stuthman pinned on flowers.

For her wedding day, the bride chose an ivory gown of satapeau over angel mist taffeta, featuring a wedding band collar and bishop sleeves. The bodice of the gown was trimmed in Cluny lace. Vertical lines of matching lace trimmed the skirt, which ended in a large ruffle. She wore a dance-length two-tiered veil of ivory nylon illusion held in place by a Camelot headpiece covered with Cluny lace and accented with seed pearls. The bride carried a cascade of multicolored flowers, baby's breath and greenery.

The bridesmaids wore mint green frocks of soft knit in floor length. Each carried a nosegay of multicolored flowers, baby's breath and greenery.

The men in the wedding party wore beige tuxedos trimmed in light brown, with white shirts also trimmed in brown.

For her daughter's wedding, Mrs. Jensen wore a long dress of peach knit. Mrs. Nobbe's long chiffon dress was in blue. Each wore a cymbidium orchid corsage.

About 150 guests attended a reception at the church following the wedding. The guests were greeted by Mr. and Mrs. Fred Wiemers, Jr. of Laurel. Gifts were arranged by Doreen Hansen, Cindy Garvin and Julie McCorkindale.

Mrs. Ronald Benton of Bonesteel, S.D. and Mrs. Norman Nobbe of Sioux City cut and served the cake. Mrs. Donald Jensen of Laurel and Edna Markley of Allen poured. Punch was served by Mrs. Larry Nobbe of Allen.

Waitresses were Judy Johnson and Linda Kvols, both of Laurel.

The bride is a 1977 graduate of Laurel High School and is activities director at Wayne Care Centre. The bridegroom graduated from Laurel High School in 1974 and is employed at Iowa Beef Processors.

Nobbes are making their home at Rt. 2, Laurel.

Mrs. Uken's Students Presented in Recitals

Mrs. Emil Uken of Wayne presented her students in piano recitals Friday and Saturday evenings at the Wayne High School lecture hall.

Theme both evenings was "Rhythmical Variations in Song."

Performing Friday evening were Selb Anderson, Charlotte Asbury, Deborah and Kristy Bull, Shelley Emry, Thomas Fletcher, Gary and Sharon Foote, Christopher, Kara and Kurt Fritz, Renee Gehner, Terri and Todd Gehner, Christy Hagerbauer, Shannon Janke, Darci Johnson, Leigh Johnson, Karen Kaup, Paula Koplin, Holly and Penny Paige, Debi Penn, Sarah Peterson, Mary Sieler, Brenda and Jennifer Wessel, and David and Steven Zahner.

Duets Friday night were by Deborah Bull and Darci Johnson, and Shelley Emry and Lori Francis.

Piano students who played Saturday evening included: Lisa and Mark Botenkamp, Bradley and Valerie Bush, Jo Carlson, Jodi Freese, Dawn Glassmeyer, Colleen Hamer, Lori and Lisa Jacobsen, Jassi and Vinl Johar, Lori Lessmann, Lesa McDermott, Jeanne Morris, Rebecca Ostendorf, Karla Otte, Lisa Peters, Cathy and Steve Peterson, Rod Porter, Debi Reese, Karen Sandahl, Karl Schultz, Anne and Lori Sorenson, Jennifer Utecht, Heidi and Wendy Wriedt, Jess and Jill Zeiss.

Anne and Lori Sorenson and Jeanne Morris and Wendy Wriedt played piano duets Saturday evening.

Students who were unable to participate in programs were Kristine Dohrman, Cindy and Jackie Filter, David Fuoss, Bethany Keidel, Eric Runquist, and Tracy Otte.

Mandy Peterson, Thomas Fletcher and Lori Francis helped with decorations and programs.

Miscellaneous Fete Given at Hoskins

A miscellaneous bridal shower was held in the Lane Marotz home at Hoskins on June 4 to honor Denise Walker of Madison.

Guests attended from Madison Norfolk, Pilger, Wisner and Altona. Hostesses were Mrs. Lane Marotz of Hoskins, Mrs. Willis Hollman of Wisner, Mrs. Kenneth Koehlmoos of Pilger and Gina Stuthman of Altona.

Miss Walker and John Snell were married Saturday at Madison.

More Social News, Page 6

Baier-Spahrl Wedding Plans Told

Making plans for a July wedding at Grace Lutheran Church in Wayne are Onar Elaine Baier and Dale Edward Spahr, both of Wayne.

Miss Baier is the daughter of Mr. and Mrs. Julius Baier of Wayne. She graduated from Wayne High School in 1977 and is employed at Bill's C.W. The bridegroom is a 1975 graduate of Wayne High School and a 1977 graduate of Northeast Technical Community College in Norfolk. He is engaged in farming. His parents are Mr. and Mrs. LeRoy Spahr of Wayne.



Showers at Dixon, Concord

Penny Burns, who will be married June 23 to Michael Kniffel, Jr. at the Holy Trinity Catholic Church in Hartington, was honored recently with two bridal showers.

Thirteen guests attended a miscellaneous bridal shower Saturday afternoon in the Marlen Johnson home at Concord. Hostesses were Kathy Dalton of Dodge, Laurie Johnson of Sioux City and Pam Johnson of Lincoln.

The guests were present from Emerson, Hartington, Dodge, Sioux City, Norfolk, Lincoln and Martinsburg.

Decorations included a floral centerpiece with candles in pastel colors.

A miscellaneous bridal shower was held Friday evening at St. Anne's Parish Hall in Dixon. Mrs. Don Roeder welcomed the 50 guests, who attended from Laurel, Allen, Dixon, Concord, Wayne, Hartington and Lincoln. Decorations were in yellow, blue, green and orange.

Mrs. Roeder presented a corsage to the honoree. A reading, entitled "My Son the Groom," was given by Mrs. LeRoy Creamer. Followed by a skit presented by Mrs. Steve Schutte, Mrs. David Schutte and Mrs. Elmer Schutte.

Helping the honoree with her gifts were Pam Johnson of Lincoln and Julie and Gene Schutte. Mary Kniffel poured and Anne Kniffel served punch.

Hostesses were Mrs. Don Roeder, Mrs. LeRoy Creamer, Mrs. William Schutte, Mrs. Elmer Schutte, Mrs. Dave Schutte, Mrs. Steve Schutte, Mrs. Duane White, Mrs. Earl Mattes, Mrs. Austin Gohler, Mrs. Paul Rahn, Mrs. Robert Dalton, Mrs. Bill Garvin, Amanda Schutte, Mrs. Leo Garvin and Mrs. Ted Johnson.

Parents of the engaged couple are Mr. and Mrs. Lowell Burns of Laurel and Mr. and Mrs. Michael Kniffel Sr. of Dixon.

LET'S TALK IT OVER

With **DARREL FUELBERTH**

As your real estate broker, once you have listed your property with us, we give you our undivided loyalty. This does not mean that we will misrepresent or try to deceive a buyer in an attempt to make a sale. It does mean that we will protect your interest at all times.

For example, if we learn that a little-known change in zoning or some unpublicized development will make your property worth far more than the price you are asking, we will tell you rather than use this information to make an easy sale and earn a quick commission. We are bound by our code of ethics to give you all the facts and aid you in adjusting your price accordingly.

Buying or selling, the best decisions are based on the best information. It costs you nothing to "Talk it Over" with us so phone us or drop in at our convenience.

Property Exchange

112 Professional Building
Wayne, NE 375-2134

Back by Popular Demand!!

Leo Perkins

NATIONAL RECORDING ARTIST

Performing Live at Les' Steakhouse

JUNE 15 - 16 - 17 8 p.m. - 12 p.m.

DON'T MISS IT!!

LES' STEAKHOUSE

375-3300 120 West 2nd

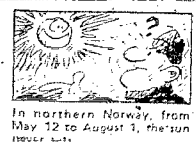

In northern Norway, from May 12 to August 1, the sun never sets.

Carroll Pitches No-hit Shutout

Doug Carroll pitched a no-hitter and he was backed by nine runs in a shutout against a young inexperienced Winside Legion team. Carroll retired 11 batters on strikeouts.

Winside had only four base runners in the game — Todd Hoemann on a walk, Tom Anderson on an error, Bruce Smith

on a fielder's choice and Carstens who was hit by a pitch. Vic Sharpe and Al Nissen scored for Wayne in the second inning after they singled and were sacrificed by Dave Schwartz and Jerry Goeden. In the third, Tom Ginn began a string of six straight runs with a

single. Kevin Murray walked, and Doug Carroll singled home Ginn. Sharpe reached first on a fielding error and brought in a run, as Murray scored. Nissen followed with a single and Carroll scored. Winside made a pitching change but Schwartz reached base on an error to load the bases. A single by Mark Ganselbom brought home Sharpe and Nissen for the fourth and fifth runs of the inning and Carroll hit a long fly ball to Schwartz home from third base on the play. Ganselbom was stranded on second base when the inning ended with the score 8-0.

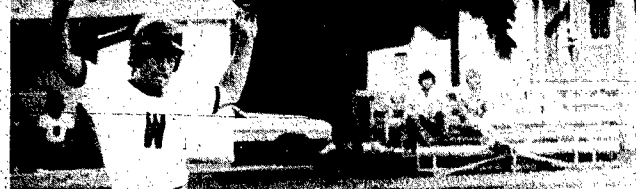

It looked as though Wayne would win the game on the 10th run in the next inning when Kevin Murray scored and Doug Carroll reached third base with no outs but Winside retired the side to end the inning. Neither team showed much action in the fifth, sixth, and seventh innings and the game ended 9-0.

Winside Juniors 000 000 — 0 0 3
Wayne 026 010 — 9 71
WAYNE AB R H
Mark Ganselbom 3 0 1
Doug Carroll 3 0 0
Tom Ginn 3 1 1
Kevin Murray 3 2 0
Doug Carroll 3 1 2
Vic Sharpe 2 2 1
Danny Ahlvers 2 0 0
Al Nissen 2 2 2
Randy Davie 2 0 0
Dave Schwartz 1 1 0
Steve Bodestedt 1 0 0
Jerry Goeden 1 0 0
Peter Manes 1 0 0
Totals 28 9 7

WINSIDE AB R H
Jay Koch 3 0 0
Tom Anderson 1 0 0
Tom Willis 3 0 0
Bruce Smith 3 0 0
Rick Anderson 3 0 0
Mitch Pfeiffer 3 0 0
Tom Koll 2 0 0
Todd Hoemann 1 0 0
Bob Hawkins 1 0 0
Gottburg 1 0 0
Russ Longnecker 0 0 0
Carstens 0 0 0
Totals 21 0 0

Baller Anyone?

TOM KOLL makes a final leap towards first base but is put out by a split second as Dean Carroll makes a long stretch to control the ball in time.



Remember All Dads Sunday, June 18! #Hallmark Remember all the fathers in your life Sunday, June 18 — Dad, Grandfather, Brother, Uncle, Son — with beautiful Hallmark Father's Day cards and gifts. The perfect way to demonstrate your love.

Midgets, Juniors Hold Blair to 4 Hits

The Wayne Midgets and Juniors held both Blair teams to a total of only four hits Tuesday night to sweep their games, 7-1, 8-5.

Wayne but was thrown out on a fielder's choice on Dennis Carroll's grounder. Pfeiffer walked and Rick Metteer doubled to bring in Carroll with the first run of the game. Jeff Dion laid down a sacrifice bunt to score Pfeiffer for the second run. Stu Nissen scored a run in the second inning to give Wayne a

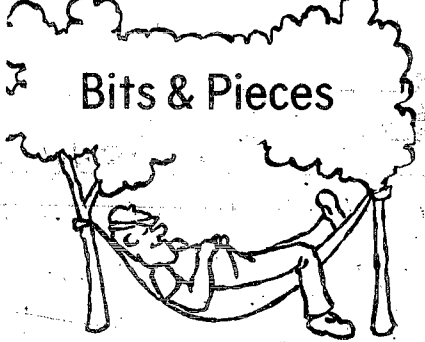

Onawa Here Tonight The Wayne Town Team will play Onawa tonight (Thursday) at 8 p.m. at the Wayne city baseball diamond. The game had originally been scheduled at Onawa's field but a conflict caused it to be rescheduled.

Slow Pitch in Sioux City A men's slow-pitch softball tournament is scheduled for Saturday and Sunday, July 8 and 9 at the Floyd Stadium Complex in Sioux City. The ASA sanctioned tourney will be double elimination and open to all non-metro teams.

Locals Place in Pickup Pull Several local persons completed and placed in a pickup pull Sunday in Ceresco. Roger Hefft of Wayne placed fourth in both the 6000 pound modified class and the 7000 pound open. Diane Hefft placed third in the stock automatic 3300 pound class and fourth in the 4000 pound stock auto class. Ken Everingham of Wakefield, in his first pickup of the season, placed fourth in the 4000 stock tick class. Kevin Fineran of Wayne placed fourth in the 5300 modified and second in the 6000 pound modified and Craig Relitz of Emerson placed third in the 5300 pound modified class. The next pickup pull is Saturday, June 17 at Malcom.

SPORTS

Wayne Midgets Scoring Spree Leads to 12-0 Win

Jeff Zeiss pitched a three-hit shutout and he and his teammates scored 12 runs to defeat Winside in Midget action Monday night, 12-0. Zeiss scored the first run of the game in the first inning.

Winside had a chance to score in the second with bases loaded and two outs but left Bill George, Tom Willis and Meikhenay stranded on base to end their threat.

In the bottom of the second, Tom Thomas doubled with two outs to begin a scoring attack for Wayne. Stu Nissen, Steve Sorenson and Zeiss all singled in the inning and Tim Pfeiffer blasted a triple to give Wayne a 5-0 lead. Nissen, Zeiss and Pfeiffer each collected an RBI.

The game ended 12-0. Winside Midgets 000 00 — 0 0 2
Wayne 123 33 12 6 2
AB R H
WAYNE AB R H
Jeff Zeiss 2 2 1
Tim Pfeiffer 2 1 1
Dennis Carroll 1 0 0
Doug Proett 1 0 0
Rick Metteer 2 0 0
Pat McCright 1 0 0
Jeff Dion 2 1 0
Brian Fleming 0 1 0
Dan Mitchell 3 2 0
Tim Thomas 1 2 1
Jeff Brant 1 0 1
Stu Nissen 2 1 1
Todd Skokan 0 0 0
Steve Sorenson 2 1 1
Jeff Baier 0 0 0
Totals 19 12 6

Again in the third inning Winside had bases loaded but couldn't get the hit they needed. Wayne scored three runs in the inning when Jeff Dion, Dan Mitchell, and Thomas reached the plate without a hit, to bring the score to 9-0.

WINSIDE AB R H
Mike Koch 3 0 0
Rick Bowers 2 0 1
Brian Scott 3 0 1
Byron Schellenberg 2 0 0
Bill George 2 0 0
Tom Willis 2 0 0
Scott Farnens 2 0 0
Meikhenay 2 0 0
Doug Jaeger 1 0 0
Hawkins 1 0 0
Totals 18 0 3

Three more runs in the fourth, gave Wayne all the scoring they needed. Doug Proett, Brian Fleming, and Thomas scored the runs for Wayne. Winside failed to score in the fifth and

Ponca Nips Town Team The Wayne Town Team rallied for four runs in the eighth inning but fell one run short of catching Ponca Sunday night, and lost the NNBL game 6-5.

Dave Hix scored the first Wayne run in the second inning. Hix walked, was sacrificed to second base by Earle Overin and scored on a single by Bill Schwartz to give Wayne a 1-0 lead.

Cage Camp Over Winners Announced

Student basketball players in grades 5-12 from throughout Nebraska and Iowa participated in the Fourth Annual Wayne State College Cage Camp, held June 4-10.

The camp, designed to give young players individualized instruction and analysis, had over 80 youngsters participating. WSC basketball coach Jim Seward said this year's participants were an outstanding group.

"Particularly in the area of defense," he said. "They were on the whole a very good offensive group, but for some reason this year's camp had a larger number of outstanding defensive players."

Each participant received a certificate of participation and an award in one of 23 categories. Coach Seward said each camp participant deserved special recognition for the efforts exhibited during the week.

"I think every camp participant is a better player after the week of workouts we just went through," he said. "Hopefully they will continue to practice and maintain or improve their

Wakefield — Scott Hallstrom, Jeff Hallstrom, Brent Kahl. Wayne — Kurl Fritz, Mr. Hardest Worker: Keith Zimmer, Mr. Hardest Worker: Mr. Spirit and Mr. H.O.R.S-E: Nick Zimmer, Mr. Spirit, Mr. Bubble Gum, Mr. Drive and Mr. Hardest Worker: Doug Proett, Most Valuable: Mr. Dunk, Mr. Quick and Mr. Defense: Joel Mosley, Mr. Intensity: Dan Gross, Mr. Desire: Scott Wessell, Mr. Sure Shot: Mark Bofenkamp, Most Improved: Todd Skokan, Mr. Defense and Mr. Intensity: Shaun Niemann, Mr. Question and Mr. Free Throw: Tim Heier, Mr. Drive.

and proved to be the winning hit when the game was over. Wayne made a big comeback in the eighth inning scoring four runs to get close, but couldn't quite get the run they needed. In the ninth and final inning, Moe Green was tagged out at home plate in a close play when he was thrown on a hit by Ray Nelson, ending Wayne's hopes.



TOM ROBERTS who won the Kolache Day Tennis Tournament in Verdugo over the weekend is busy teaching students of all ages the basics of tennis. He is also planning two tournaments sanctioned by the U.S.T.A.

Ponca had two home runs during the game and the first one came in the third inning with two runners on base. John Kingsbury rapped the three-run homer after his teammate Steve Bevezheimer had scored the first run of the inning and two others got on base to make the score 4-1 after three innings.

Wayne 004 002 000 — 6 9 4
Wayne 010 000 040 — 5 7 1
AB R H
WAYNE AB R H
Marty Hansen 2 0 0
Rod Cook 1 0 0
Jerry Lutt 4 0 0
Abe Green 5 1 3
Ray Nelson 5 1 1
Aaron Nissen 5 1 1
Monie Lowe 1 0 0
Dan Ginn 3 0 0
Earle Overin 3 0 1
Bill Schwartz 2 0 1
Bob Nelson 1 0 0
Akie Meyer 4 0 1
Totals 37 5 7

Town Team Baseball Tonight

THE LOFT Has Just The Right Selection Of Masculine Items For The Fathers In Your Life.
Travel Bars
Ice Buckets
Games & Puzzles
Desk Accessories
Dresser Valets
Wrought Iron
Patio Bells
And More!

PRESCRIPTIONS Are Our Specialty. Get Your Next Prescription At Sav-Mor Drug — Where It Costs Less To Get Well.

SAV-MOR DRUG
Walgreen AGENCY
1022 MAIN PHONEX 375-1444

PROTECT YOURSELF AGAINST CROP LOSS
SEE DICK... for a good competitive rate!
FIRST NATIONAL AGENCY
Dick Dittman, Manager
303 Main Wayne, Nebraska Phone 375-2511

Bits & Pieces
RaceResults
Grand Island Gene Brudigan — 3rd in 1st heat, 4th in A feature.
Sioux Falls Gerald Bruggeman — 1st in 1st heat, 1st in Trophy Dash, 3rd in A feature; Gene Brudigan — 1st in 2nd heat.

Randy's RECAP
According to Randy Hascall
lawn where they evidently decided to deposit the leftovers from a party. The counselors must not have been doing their jobs supervising the kids to keep them out of trouble, and it doesn't look very good for the college to let something like this happen. Next time I hope discipline is presented effectively to make the cage camp a success in future years. The basketball camp is a privilege, for young players to take advantage of — not misuse.

Results and Schedule
Girl's Softball Results
13 and under
Winside 15, Wakefield 8 — Winning pitcher: Kerry Leighton was four for four at the plate and rapped a home run to lead Winside in Ralph Bishop's league action. Also contributing to the winning cause were Kim Schueter, Kerri Leighton and Kathy Gortberg all with three hits in their trips to the plate. Leading hitters for Wakefield were Christy Clayers and Christy Miller with two hits each.
15 and under
Winside 13, Wakefield 4 — Robin Winch went three for four at bat and Joan Bowers and Tammy Thomas each had two hits to back up the
four-hit pitching of June Meyer.
18 and under
Wakefield 18, Winside 3 — Mary Kober picked up two-hits including a home run and Kathy Gustafson, J. Miller and Lisa Paul added three hits apiece to lead the Wakefield hitting attack. Kim Lago, Lisa Longnecker, Joan Bowers and Kathy Thomas had two hits each for Winside in the losing cause. J. Miller was the winning pitcher.
Women's Softball Results
Columbus Federal 16
Bill's GW 12
Summer Swingers 18
Eagles 8
Goch's Best 5
Triangle Finance 1
The Joint 6
PMC 1
The Headquarters 20
Fearless Four 0
MIDGETS and LEGION
Friday, June 16
Wisner at Wayne
Emerson at Wakefield
Winside at Laurel
Bancroft at Pender
TOWN TEAMS
Thursday, June 15
Onawa at Wayne
Ponca at Newcastle
PONY AND LITTLE LEAGUE
Thursday, June 15
Winside at Laurel
Pender at Wakefield
Emerson at Wayne

Join the crowd!
Try A Fantastic FISH FILLET 89¢
Lil' Duffer
FAMILY RESTAURANT
Wayne 706 Main 375-1900

IT'S EASY TO BUY-SELL-RENT-HIRE & FIND WITH WANT ADS

WANT ADS

For Sale

FOR SALE: Penny's 8 Track Car Tape Player. Call Shelly at 375-1497. j9

FOR SALE: Round trampoline with safety pads. Best offer. 375-4455. j1513

FOR SALE: 20 foot electrical conduit (3 wire). 375-2673. j151f

Misc. Services

si' PER DAY rental for Electric Carpet shampooer with purchase of Blue Lustrite. McNatt Hardware, Wayne. m11f

WATERTOWN MONUMENT CO.

Buy Direct From The Factory and Save. Local Representative, Virgil Luhr Phone 375-2498

FOR YOUR grain storage erect a Ross or Super Steel Bin, either Hi-Moisture or Aeration systems. Call George Young 665-2532 Oakland or Russ Zichl 439-2353 Stanton. m1512f

500 Gilts Available beginning July 10th. All are guaranteed open. Have 12 functional nipples and are structurally sound and health checked. Call your Bear Power's Bear Sales Center now to reserve purchase or for more information. Phone (402) 371-2630

BOAR POWER.

DESIGNS/RIGHTS/PATENTED SYSTEM By Monsanto

FOR SALE—1970 Chevy 4 door. Good condition. Air conditioning, power steering, 3 speed. \$500 or best offer. Phone 375-9984 and ask for Pat Riibe. j15

CAMPER FOR SALE: 16' Mobile Traveler (1975), self-contained; gas-furnace, refrigerator and stove; 12V-110V; several extras. Tony Netherland, Wayne, 415 East 10th, Ph. 375-2439. j15

GOT A BARN OR out building that needs a steel roof? Call L & L Construction for a free estimate. 585-4879. j15

MOVING?

Don't take chances with your valuable belongings. Move with Aero Mayflower, America's most recommended mover.

Abler Transfer, Inc. WILL DO babysitting in your home. Call 375-3897. j1512

State National Bank & Trust Company

welcomes the opportunity to handle your orders for purchase or redemption of U.S. Government Securities

Business Opp.

PARTY PLAN SUPERVISORS

Merri-Mac toy parties has openings for supervisors and demonstrators in your area. Quality merchandise — Highest commission. No investment, delivering or collection. Call Ann Baxter collect 319-556-8881 or write MERRI-MAC, Box 1277, Dubuque, Iowa 52001.

DEALERS WANTED

To handle a major line of pre-engineered steel bins and buildings. Lucrative opportunity for the right person. Aggressive farm operator considered. Call (800) 225-4400.

For Rent

TWO BEDROOM basement apartment for rent. Ph. 375-2767. j121f

FOR RENT: Rooms, efficiency apartments and one bedroom apartment. Phone 375-2252. j51f

Real Estate

NEW LISTING

NEED LISTINGS — HAVE BUYERS PROPERTY EXCHANGE

112 Professional Building Wayne, Ne. Phone: 375-2134

HOUSE FOR SALE IN LAUREL

Large two story home featuring living room, formal dining room, family room with sliding doors to deck, kitchen, laundry room and 1/2 bath on main floor. Second floor, four bedrooms, bath. Lower level, rec room with wet bar, bath and walk-out. Attached garage. Priced in 550's. Call: Chet Joslin Agency Sioux City, Iowa (712) 277-8140

HOME FOR SALE

512 W. 2nd St. Wayne Contact Florence Grewe, 375-3140 or Evelyn Galtje, 375-3079

Wanted

WANTED TO RENT IMMEDIATELY: House, apartment or room in or near Winside. Contact Mary Cherry at the Winside Dehy. Ph. 286-4491 or call collect 283-4891. j1212

Wanted

BABYSITTER NEEDED: For two toddlers in Wayne. Weekdays. Phone 287-2556. j1513

HISCOX-SCHUMACHER FUNERAL HOMES

Wayne Carroll

The Wayne (Nebr.) Herald, Thursday, June 15, 1978

WAYNE STATE COLLEGE VACANCY NOTICE

CUSTODIAN I: Performs general custodial duties... **PAINTER II:** Performs skilled work in the application of protective and decorative finishes...

Card of Thanks

WE WISH TO express our deepest gratitude and heartfelt thanks to all our friends, neighbors and relatives for the flowers, food, cards of sympathy and memorials sent at the time of the loss of our beloved son, brother and grandson, Randall Lee Rees. A special thanks to the WAMS for the dinner, the Concord Youth Group for the cards, the anonymous donors, the people responsible for reinstating our telephone, Pastor Lindquist, and the Hiscox-Schumacher Funeral Home. It is such a comfort to know so many people share our loss. May God bless you all. Ellie Mae Rees, Richard, James, Jeffrey, Brian and Brenda Rees, Jennifer Kuhnenn, Mr. and Mrs. Elmer Rees. j15

I WOULD LIKE TO thank all my friends and relatives for the cards, visits and flowers and good care I got while in the Providence Medical Center. Special thanks to all the nurses and Dr. Robert Bentback and to Pastor Edmonds for his prayers. May God bless each and every one. Mrs. Lottie Longnecker. j15

NEED LISTINGS — HAVE BUYERS PROPERTY EXCHANGE

112 Professional Building Wayne, Ne. Phone: 375-2134

Help Wanted

HELP WANTED Openings now available for welders, punch press, press brake, sheet metal shear, and duplicator torch operators. Experience preferred. 45 hr. Week; Vacation, Insurance, and Profit Sharing Plans; Paid Holidays; Apply in person, Monday thru Friday, 8:4-3:00 at Automatic Equipment Mfg. Co., Pender, Nebr. j1514

Just in Time FOR FATHER . . .

SPECIAL \$16.95

THIN-MAN LCD 8-DIGIT CALCULATOR. Ultra-thin—just 7mm! With direct access memory, square root, one-tenth percent and a double function clear key. Long battery life—approximately 1200 hours. Notebook case. EE18128

AND MOTHER . . .

SPECIAL \$32.95 Reg. \$44.95

HOOVER CELEBRITY VACUUM CLEANER

Lightweight. Instant on-off toe switch. Unbreakable combination rug and floor nozzle. Throw-away bags with 10-quart capacity. Flamingo and Antique Copper Base. S3005

SHERRY BROS.

True Value FARM & HOME CENTER Hardware Stores Phone 375-2082

GOODYEAR

VACATION TIME TRUCK TIRE SALE

Tire up for your trip and save! Choose your size and type... then see us now. Sale ends this Saturday night.

SPECIAL Rib Hi Miller T.T. 4 ply \$36.00 + \$2.85 F.E.T.

SPECIAL Wide Tread 10-15 LT 4 ply \$60.00 black + 4.23 F.E.T.

SPECIAL Tracker L.T. XG tube type \$44.00 + 1.12 F.E.T.

REPLACE WORN TIRES NOW

Size	Ply Rating	Load Range	Type & Description	SALE PRICE	Plus F.E.T. No trade-in
750x18	6	C	Hi-Mi Miller Nylon	42.50	3.00
750x16	8	D	Rib Hi Miller Nylon	59.50	7.61
825x20	10	F	Hi-Mi Miller Special	45.00	6.53
900x20	10	F	Hi-Mi Miller Special	120.00	7.54
1000x20	12	F	Hi-Mi Miller Special	152.00	9.75
950x20	0	E	Cross Rib Special	142.00	8.41
2000x20	10	F	Cross Rib Special	173.00	12.20

SPECIAL Tracker L.T. 875x16.5 8 ply tub 1.5 \$59.00 + 3.92 F.E.T.

Liberal Budget Terms... Low Monthly Payments

Coryell Derby

211 Logan 375-2121

CARROLL NEWS / Mrs. Ed Fork 585-4827

Bible School Ends With Luncheon

Vacation Bible school classes at St. Paul's Lutheran Church ended Friday, following a week of study and crafts. Theme was "Jesus, Jesus, Only Jesus." Mothers and other guests attended a luncheon Friday afternoon. Youngsters sang and displayed their work. Teachers served, cake, cookies and ice cream furnished by AAL Branch 3019.

Presbyterian-Congregational Church
(Gall Axen, pastor)
Sunday: Combined Bible study at Congregational Church, 9:15 a.m.; worship, 10.

United Methodist Church
(Al Ehlers, lay speaker)
Sunday: Worship, 9:30 a.m.; Sunday school, 10:30.

The Ralph Olsons left June 1 to take her sister, Mrs. Margaret August to her home in Denver. Mrs. August had spent several days visiting in the area. Olsons returned home June 5.

The Joe Lapaceks of Schuyler were dinner guests Sunday in the Ralph Olson home.

The Tom Olson family, Norfolk, were Friday guests and the Lowell Olsons and Jody were guests Saturday evening in the Ralph Olson home to help their parents observe their wedding anniversary.

The Harry Nelsons of Carroll and the Lyle Petersers of Osmond went to Hay Springs Thursday to attend funeral services for Ed Kutchera, an uncle of the men. They returned home Friday.

The Harry Nelsons of Carroll and the Merlin Harmelers of Norfolk went to Sioux City Sunday afternoon where they were guests in the Mel Harmeler home to honor their silver wedding anniversary.

Mrs. Lyrell Thomas of Mankato, Minn., returned home Thursday after visiting in the home of her daughter and family, the Don Davises. Mrs. Kenneth Hall and Mandi, the Earl Davises and Mrs. Agnes Duffy were coffee guests June 8 in the Don Davises home to visit the Minnesota guest.

Mr. and Mrs. Hayden Owens and Nancy of Fenimore, Wisc. were weekend guests of his father, Owen Owens. Mrs. John Teidgen of Adams also visited.

Mr. and Mrs. Gilmore Sals, Mrs. Anna Hansen, Arnold Hansen, the Arthur Cooks, the Russell Halls and the Edward Forks, all of Carroll, attended funeral services in Sioux City Monday for Mrs. C.E. Fredrickson.

St. Paul's Lutheran Church
(G.W. Gottberg, pastor)
Sunday: Worship, 9 a.m.; Sunday school, 9:50.



Planting Time

THE LANDSCAPE at City Hall was enhanced when these "gardeners" put flowers in a bed on the corner of the city property. Working are (left to right) Jociele Bull, Virgil

Chamber, Cordelia Chamber, Anton Pedersen, Mabel Sundell, Alice Dorman and Craig Butford. Man in the back ground is not identified.

HOSKINS NEWS / Mrs. Hilaa Thomas 565-4569

Ordination Service Set At Peace United

Peace United Church of Christ will conduct an ordination service this Sunday evening for Roger Kube, a former member of the congregation.

There will be a potluck supper at 5 p.m., followed by the ordination service at 6:30.

Campfire Service
Girl Scout Troop 202 and Cub Scout Pack 168-Den. 6 held a campfire service Sunday evening at the Peace United Church of Christ. Families were guests.

The program included group singing and skills. A film, entitled "Drama in Nature," was shown. A marshmallow roast was held at the close of the evening.

Birthday Honored
Mr. and Mrs. Lanny Maas entertained the Cub Scouts at a wiener roast Saturday evening

in honor of Layne's ninth birthday. The boys made Father's Day gifts and practiced a skill for their campfire service.

Brownies Meet
Brownie Troop 201 met June 6 at the fire hall and opened the meeting with the Girl Scout Pledge.

The girls hiked to the Richard Behmer home where they played games. Mrs. Behmer served refreshments.

The June meeting and hike marked the final meeting for the season. The girls are planning to attend camp at Ta-Ha-Zouka Park in Norfolk next week.

Dine Out
Members of the Highland Women's Extension Club met at Becker's Steakhouse in Norfolk for dinner Thursday.

Afterward, the group played

cards with prizes going to Mrs. George Langenberg and Mrs. Lane Marolt. Later in the afternoon they toured the new Norfolk City Library.

The club is planning a family picnic on July 13 at 7:30 p.m. Skyview Park in Norfolk.

Peace United Church of Christ
(Galen E. Halm, pastor)
Sunday: Worship, 9:30 a.m.; Sunday school, 10:30.

Zion Lutheran Church
(Jordan Arlt, pastor)
Sunday: Worship, 9 a.m.; Sunday school, 10:15.

Trinity Evangelical Lutheran Church
(Wesley Bruss, pastor)
Thursday: LWMS, 1:45 p.m. Sunday: Worship with communion, 9 a.m.; Fellowship Club, 7:30 p.m. Tuesday-Thursday: Nebraska

District Delegate Convention at Denver.

Social Calendar
Thursday, June 15: LWMS, Trinity school basement; Cub Scout Troop 168 Den 6 pack meeting, fire hall.

Saturday, June 17: Helping Hand Club dinner, Becker's Steakhouse, Norfolk. Monday, June 19: Spring Branch 4-H Club, Hoskins Public School; Kid Power 4-H Club, Ed Gnirks.

Weekend guests in the E.C. Fenske home were the Les Jons and family of Lake Havasu, Ariz.; the Don Luteses of Lafayette, Colo.; and Mrs. Rose Clasen and Richard of Colorado Springs, Colo.

The Erwin Ulrichs and the Harold Wittlers and Kari went to Birchdale, Minn. Thursday. Wittlers visited with her

OBITUARIES

Walter Woods

Services are pending at the Hixcox-Schumacher Funeral Home in Wayne for Walter Woods, age 66, of Wayne. He died Tuesday evening of his home in Wayne.

'Gray Water' Can Be Used

The use of gray water is becoming more of an accepted practice. This water is water that has been used once — in washing machines, dishwashers, showers and bathtubs and kitchen sinks.

These gray waters can be used in the home garden but certain facts should be known about them. Detergents which are found in the washing machine water are sodium salts of various organic acids. Soaps which are found in shower and tub water and some kitchen sink water are sodium or sometimes potassium salts of certain fatty acids. This sodium is not used

by the plants. It also accumulates in the soil and may reach toxic levels. Potassium, even though it is used by plants, may reach toxic levels also. The use of gray water depends on several factors. The first is the concentration of the soaps and detergents in the gray water. The greater the concentration of these particular elements.

Not all plants can use gray water. Because of its alkaline nature, gray water should not be used on acid-loving plants. Monocots tend to tolerate gray water and grass seeds to tolerate sodium quite well.

When injury does occur, gypsum can be used. Gypsum contains calcium, which replaces sodium in the exchange reaction of the soil. The sodium can then be leached out of the soil by additional water.

It is important not to use soaps or detergents which contain boron, as this is very toxic to plants and low concentrations will affect them. Water with bleach in it can be used, but should be allowed to stand in the sun one day before using. Bleaches break down in the presence of light and air to form less toxic salts.

Plants vary in their sensitivity to gray water, so damage is more likely to occur in container-grown plants than those grown in open ground. Therefore, when using gray water, do not use it on plants in containers.

Library Carpet

The Wayne-Carroll school board of education Monday night authorized Supt. Francis Haun to take bids on carpeting for the high school library. The lute back carpeting will cost an estimated \$2,850.

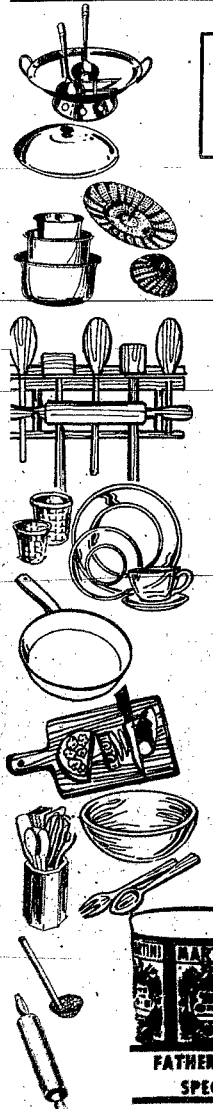

YOU ARE CORDIALLY INVITED TO OUR *Grand Opening*

THURSDAY - FRIDAY - SATURDAY **June 15 - 16 - 17**

REGISTER FOR \$100 WORTH OF FREE PRIZES

- ★ Wok ★ Grateful Bread Plate ★ Pastry Board ★ Kitchen Scale ★ Portable Burner ★ Espresso Coffee Maker

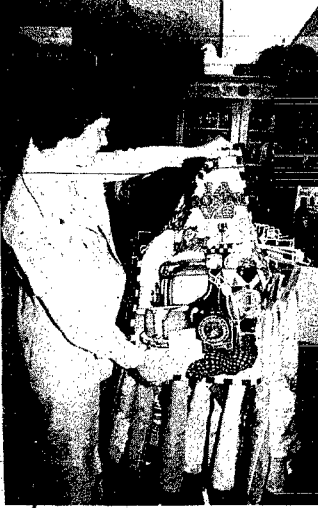

Wayne Area Mother of the Year, Donna Liska, looks over the selection of gift at The Cupboard.

CERAMIC STACKING MUGS

BUY FIRST MUG AT REGULAR PRICE RECEIVE SECOND FOR 1/2 PRICE

- Cinzano
- Martini
- Lea & Perrins
- Colman's
- Guinness

FATHER'S DAY SPECIAL

Free Coffee and Donuts

During Our Grand Opening Celebration

THE CUPBOARD

GIFTS FOR YOUR KITCHEN

Wayne **375-1227**

307 Pearl

JUNE 18th IS FATHER'S DAY

Broccoli and Pea Casserole

- 1 package (10 oz.) Frozen Peas
- 1 package (10 oz.) Frozen Chopped Broccoli
- 1 can Cream of Mushroom Soup
- 1 small jar Cheese Whiz
- 3/4 cup buttered Crumbs

Cook vegetables until barely tender; drain. Heat soup and cheese. Blend with vegetables. Place in a buttered 8-inch square pan. Top with crumbs. Bake at 350 degrees for 25 to 30 minutes or until bubbly and brown.

Mrs. Alvin Wagner
Hoskins, Nebr.

Chicken Casserole

- 2 cans Cream of Mushroom, Celery or Chicken Soup
- 2 cups Milk
- 2 cups cut-up cooked Chicken or Turkey
- 2 cups uncooked Macaroni
- 1 small Onion
- 3/4 cup Cheese, grated
- Salt and Pepper to taste

Combine soup and milk. Fold in remaining ingredients. Combine thoroughly and cover and store in refrigerator overnight. Bake at 350 degrees for 1 hour.

Mrs. Alvin Niemann
Winside, Nebr.

Cherry Dessert

- 1 1/2 cups Pineapple Juice and Water
- 2 (3 oz.) packages Cherry Gelatin
- 2 cans Cherry Pie Filling
- 1 cup drained Pineapple Tidbits
- 1/2 cup Miniature Marshmallows

Heat juice and water to boiling. Add gelatin and stir to dissolve. Cool until slightly thickened. Beat until fluffy. Fold in cherry filling, pineapple and marshmallows. Pour into a mold or pan. Garnish with whipped cream.

Linda Grubb
Wayne, Nebr.

Cherry Pie Salad

- 1 can Sweetened Condensed Milk
- 1 (9 oz.) Whipped Topping
- 1 (11 oz.) can Mandarin Oranges, drained
- 1 (8 1/2) can crushed Pineapple, drained
- 2 cups Miniature Marshmallows
- 1 can Cherry Pie Filling
- Coconut

Mix milk and whipped topping. Fold in rest of ingredients and chill. Freezes well.

Mrs. Anna Black
Wayne, Nebr.

Lemonade Pie

- 1 can (small) Lemonade
- 1 can Sweetened Condensed Milk
- 1 (9 oz.) container Whipped Topping
- Vanilla Water Crust

Thaw lemonade and pour into milk. Stir well. Fold in whipped topping. Pour into pie shells, sprinkle dry vanilla wafer crumbs on top. Chill. Makes 2 eight-inch pies.

This can be made the day or evening before you serve it.

A light dessert and quick to prepare.
Peg Lutt
Wayne, Nebr.

Serve Him
One Of
These
Delicious
Recipes!

Shop
Annie's
Johnson
Frozen Foods
and
Wittig's
for all
your
grocery
needs!



Oatmeal Bars

- 1 cup Quick Oatmeal
- 1/2 cups Boiling Water
- 1 cup Sugar
- 1 cup firmly packed Brown Sugar
- 1/2 cup Oleo
- 2 Eggs
- 1 teaspoon Vanilla
- 1 1/2 cups Flour
- 1 teaspoon Soda
- 1/2 teaspoon Salt

Pour boiling water over oatmeal and let stand for 20 minutes. Cream the sugar, brown sugar and oleo. Add eggs and vanilla to creamed mixture. Sift together the flour, soda and salt and add to mixture. Add oatmeal last. Spread in a greased pan and bake for 25 minutes in a 325 degree oven. (Frosting recipe below).

Frosting

- 6 tablespoons Oleo
- 1 cup Brown Sugar
- 4 tablespoons Milk

Boil oleo, sugar and milk. Beat until cool.

Mrs. Warren Korth
Clovis, New Mexico

Strawberry Macaroon

- 1 package (1 lb., 3 oz.) Yellow Cake Mix
- 1 Egg
- 1/4 cup Water
- 1/4 cup Oil
- 1 cup Coconut
- 1 small package Whipped Topping
- 1 quart Sweetened Strawberries
- 1/2 cup Coconut

Combine cake mix, egg, water, oil and 1 cup coconut. Mix well. (Mixture will be very thick.) Pour into a greased 9 x 13-inch pan. Bake 18 to 20 minutes in a 350 degree oven. Cool.

Combine whipped topping and sweetened strawberries. Spread over cooled cake. Top with 1/2 cup coconut. Keep refrigerated.

Mrs. Harold Korn
Wayne, Nebr.

Fudge Brownies

- 2 sticks Oleo
- 4 squares Baking Chocolate
- 4 Eggs, beaten
- 2 cups Sugar
- 1 cup Flour
- Dash of Salt
- 3/4 cup broken Walnuts

Cook oleo and baking chocolate in double boiler a few minutes. After chocolate is melted, cool. Mix eggs and sugar together and beat until thick. Add flour, salt and broken walnuts as well as cooled chocolate mixture. Bake in a greased and floured 10 x 15-inch pan at 350 degrees for 20 to 25 minutes. (Frosting recipe below.)

Frosting

- 1 stick Oleo
- 1 pound Powdered Sugar
- Dash Salt
- 3 to 4 tablespoons scalded Milk
- 1 Egg White
- 1 teaspoon Vanilla
- Cocoa to color and taste (added last)

Mrs. Helen Zimmer
Wayne, Nebr.

OBITUARIES

Mrs. C.E. Fredricksen

Mrs. C.E. Fredricksen, age 89, died June 9 at a Rest Home in Sioux Falls, S.D. She is the wife of the late Rev. Fredricksen. Funeral services were held at the St. Paul's Lutheran Church in Sioux City Monday morning.

Survivors include two sons, Carl of Phoenix, Ariz., and Willis of Newark, N.Y.; three daughters, Mrs. Vera Giribon, Carfield, Heights, Ohio, Mrs. Erma Peterson, Sioux Falls, S.D., and Mrs. Valetta Berg, Sioux City; grandchildren and great grandchildren.

Blanch Harrison

Funeral services for Mrs. Blanch Harrison, age 79, were held June 8 at the Mohr Funeral Home at Ponca with the Rev. George Francis of Wayne officiating.

She died June 5 at the Elms Nursing Home in Ponca. Six grandsons served as pallbearers and burial was in the Concord Cemetery.

Blanch Irene Barber was born Dec. 9, 1888 at Ponca. On Oct. 30, 1905, she married Sherman Harrison at Elk Point, S.D. He died Feb. 18, 1947, at Dixon.

Survivors include two sons, Floyd of Long Beach, Calif., and Darrell of Wayne; five daughters, Mrs. Eveline Clarke, Kirksville, Mo., Mrs. Frank (Dorothy) Stepanick, Douglas, Wyo., Mrs. Raymond (May) Malcom, O'Neill, Mrs. George (Thelma) Sullivan, Marlinsburg, Mrs. Ralph (Maxine) Peterson, Wayne; 34 grandchildren; 64 great grandchildren; one brother, Clarence Barber, Napa, Calif., and one sister, Mrs. Jessie Doctor, Long Beach, Calif.

Mrs. George Averman

Funeral services for Mrs. George (Vesta) Averman of Wakefield will be held today (Thursday) at 2 p.m. at the Presbyterian Church in Wakefield.

She died Monday at the Wakefield Hospital at the age of 88.

Survivors include one daughter, Mrs. Eldon Hart of Leigh Nebr., two grandsons and three granddaughters.

Emma Hesemann

Funeral services for Emma Hesemann of Owensville, Mo., were held Wednesday at the Golenstrater Funeral Home in Owensville.

She died Sunday at the Charleston Hospital at Jefferson City, Mo., at the age of 90 years. She was born Nov. 19, 1887, at Drake, Mo.

Survivors include one sister, Mrs. Emil Lattmann of Owensville, and eight nephews and nieces, including Mrs. Eveline Thompson of Wayne and Mrs. Arnold Junck of Carroll.

Roll Call is 'Special Wedding'

Mrs. Marvin Rewinkle hosted nine members of the Pleasant Dell Club Thursday afternoon. Roll call was answered by a "Special Wedding."

Games were played for entertainment. A picnic was planned for July 13 at 1:30 p.m. at Ponca State Park. July 28 they plan to play bingo with the residents at the nursing home.

Mrs. Kermit Turner will host the September 14 meeting at 2 p.m.

St. John's Lutheran Church (Ronald E. Helling, pastor)
Sunday: No Sunday school; Vacation Bible school picnic at the park, 10 a.m.
Monday: Bible class, 2 p.m.; AAL picnic at St. Paul's

Lutheran Church, 7:30
Tuesday: S.C.F., 2 p.m.
Salem Lutheran Church (Robert V. Johnson, pastor)
Thursday: Lutheran Church Women workday, 1 p.m.; Luthe-

ran Church Women, 8 (note change of day and time).
Sunday: Sunday school, 9 a.m.; worship, 10:30.
Tuesday: XYZ group, 2 p.m.
Evangelical Covenant Church (E. Neil Peterson, pastor)
Sunday: Sunday school, 9:45 a.m.; worship, 11; Sr. - Hi. League, 6 p.m.; evening service, 7:30.
Tuesday: CSC meeting and potluck dinner, 12 noon.

Wednesday: Cottage prayer meeting, 8 p.m.
Christian Church (Charles Gard, pastor)
Thursday: Kings Daughters, 2 p.m.
Sunday: Sunday school, 9:30 a.m.; worship, 10:30.
Immanuel Lutheran Church (Ronald E. Helling, vacancy pastor)
Thursday: Ladies Aid, 2 p.m.

Sunday: Worship, 8:30 a.m.; Sunday school, 9:30.
Social Calendar
Thursday: Home Circle, 2 p.m.
Sunday: Friendly Tuesday, Club family picnic, Wakefield Park, 6:30 p.m.
Tuesday: Allen Keagle-VFW Auxiliary, Mrs. Randall Blaffert, Graves Library meeting room, 8 p.m.

GAMBLES Summer Value Days

Look for SUPER BUYS throughout the store! USE YOUR CREDIT!



9.88
REG. 12.95
SAVE 23%
12-Cup Airtop Keps beverages hot or cold up to 24 hours!



2.99 SPECIAL!
2-Ply Vinyl Garden Hose
1/2"x50-ft. Solid brass couplings. Save today at Gambles!



99¢ REG. 1.59
SAVE 37%
8-Oz. Johnson's Kit Wax
Cleans as it waxes. Pre-sottened for smooth coverage.



14.88 REG. 19.99
SAVE 3.11
Smoke and Fire Detector
Operates on 9-volt alkaline battery (included). Test switch.

BIG CAPACITY FREEZER SALE!

Your Choice **\$299** SAVE \$20 From Our Regular \$319 Low Price



16-Cu. Ft. Upright
Features adjustable cold control, two fast freeze shelves, one adjustable dry shelf, five deep door shelves. Fiberglass insulation, magnetic door gaskets, cold sealed in. 61" Hx32" Wx26 1/2" D

Coronado



20-Cu. Ft. Thinwall Chest
Two lift-out baskets handy for small items. Defrost grain, recessed handle, and magnetic lid gasket. Cabinet 35" Hx57" Wx27" D White

HOLDS UP TO 559 LBS.

HOLDS UP TO 708 LBS.

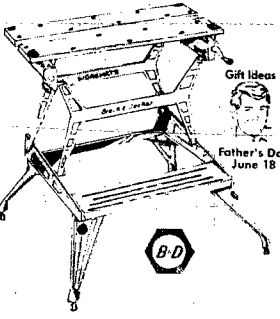

69.87
REG. 79.95
SAVE 10.08
Workmate® Work Center
Holds objects up to 12" wide. Folding legs adjust to two heights. Sturdy steel frame. Portable.

Folds for easy carrying and storage

Over 1800 Nuts, Bolts and Screws in 25-Tray Cabinet ALL FOR ONLY 19.97

REG. 24.99
SAVE OVER \$5
Just about every nut, bolt, screw, washer, and cotter pin you'll ever need in one organized cabinet of high-impact plastic!



WORKSHOP BONANZA!

EYE-CATCHING DAD'S DAY GIFTS

from **WAYNE BOOK STORE**

Unique 8-Digit Desk Top Unit

The perfect gift for the active "today" DAD!

A WIDE VARIETY OF FUNCTIONS

- Clock • Alarm • Stopwatch • Calculator
- Calendar • World Time

A VERY "TIMELY" GIFT FOR ONLY **\$79.95**

COME IN AND BROWSE — WE HAVE SOMETHING FOR EVERYONE

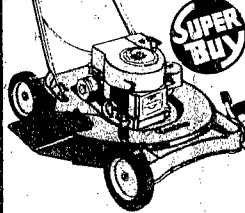

99.95 REG. 112.95
SAVE \$13
Deluxe 20" 3/4-HP Rotary Mower
Dependable 4-cycle B&S engine with vertical pull start. Lo-Tone muffler, easy ht. adj.

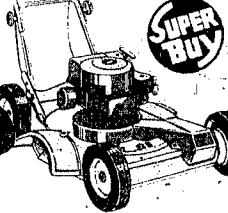

184.88 REG. 199.88
SAVE \$15
Self-Propelled 21" Rotary Mower
3 1/2-HP 4-cycle engine. Fully baffled cast aluminum deck, folding handle for convenient storage.



129.95
REG. 149.95 **SAVE \$20**
In-Dash 8-Track Stereo Radio with AM/FM Stereo Radio
Vertical head system, dual channel amplifier, volume and tone controls, DX/local switch and radio dial on cartridge door. Save!

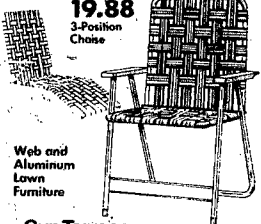

19.88
3-Position Chair
Web and Aluminum Lawn Furniture

Sun Terrace
788
Chair REG. 9.95
SAVE 20%

Lead Crystal Collection

Beautifully etched and sculptured full lead crystal display pieces imported from Austria add a note of distinction to any desk or table top.

Follow Your Dream

Hallmark Desk Set

ONLY \$975

Picturesque pen base and pen.

Sharp Electronic Calculator

EL-8034

JUST **\$14.95**

Just in time for Dad's Day!

FREE WE WILL PERSONALIZE YOUR DAD'S CALCULATOR

4.97 REG. 5.99
Ortho Weed-B-Gon
2.98 8-Oz. Isotox Insecticide
2.98 8-Oz. Malathion Insecticide
Kills aphids, flies, more. Makes up to 24-gal. diluted spray.

3.99 REG. 5.49
Lawn Oscillating Sprinkler
Provides uniform water distribution. Up to 2,350 sq. ft. coverage.

39.88
REG. 44.95 **SAVE 5.07**
Rugged 8 1/2-Ft. Tubular Steel Gym Set
2 plastic swings, tubular trapeze, two-passenger glider. Red/white/blue non-toxic baked enamel finish.

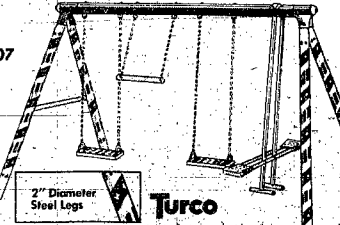

Turco

17.88
REG. 21.95 **SAVE 4.07**
Sleeping Bag with 3-Lbs. Polyester Fill
With full separating zipper and cotton flannel lining. Fully washable.



1.88
REG. 2.29 **SAVE!**
Folding Camp Stool
Wood frame, canvas seat.



Go Gambles

Family Plans

CHARGE IT

213 Main Wayne, NE

COLUMBUS FEDERAL

introduces TWO NEW

SAVINGS CERTIFICATES

(effective June 1, 1978)

8%
8.33%
compounded continuously

\$1,000 minimum
8-year term

Deposit now \$1,000 minimum for 8 years and compounded continuously, returns 8.33%

6 mo. certificate
\$10,000 minimum

Purchase a 6 month (money market savings) certificate with \$10,000 minimum deposit and receive a rate 1/4 percent higher than average yield on 6 month bills at the Treasurer's weekly auction which can vary from week to week. For week ending June 21, 1978 the rate paid by Columbus Federal was 7.371 percent.

Remember Our Premium Offer—The Barrington Jewelry Collection or Green Stamps

Federal Law requires substantial penalty for early withdrawal



HOME OFFICE — 14th St. & 26th Ave.
Phone 344-3234
Columbus, Mo. 63601



Seward Office — 310 No. 5th St.
Phone 643-3631
Seward, Mo. 64434

Wayne Office — 220 West 7th
Phone 375-114
Wayne, NE 68477

WINSIDE NEWS

Mrs. Ed Oswald
286-4872

New Officers, Committees Named

Neighboring Circle met Thursday afternoon to elect new officers and committees.

Officers for the coming year are Mrs. Wayne Denklaue, president; Mrs. Ray Jacobsen, vice president; and Mrs. Robert Koll, secretary-treasurer.

Serving on committees are Mrs. Herbert Jaeger, flowers; Mrs. Eldon Herbolzheimer, song leader; Mrs. Wayne Denklaue and Mrs. Eldon Herbolzheimer, party; Mrs. Hans Carstensen and Mrs. Richard Carstensen, year-books; Mrs. Henry Langenberg, Christmas dinner; Mrs. Richard Carstensen and Mrs. Wayne Denklaue, Christmas dinner entertainment; Mrs. Robert Koll, kitchen for the Christmas dinner; and Anna Koll and Mrs. Henry Langenberg, auditors.

The club held its June meeting in the home of Mrs. Dora Ritze. Eight answered roll call by coming as they were. Mrs. Ella Reinhardt of Wayne was a guest.

The meeting was conducted by Mrs. Denklaue. The group sang "God Bless Our Native Land." The club is planning to celebrate its 50th anniversary on July 16 at 2 p.m. at the Legion Hall in Winside. The public is invited.

Pitch furnished entertainment and prizes were won by Mrs. Henry Langenberg and Natalie Smith.

Next regular meeting is July 11 at 8 p.m. in the Ray Jacobsen home to complete anniversary plans.

New Books

The Winside Public Library has received several new books. They include:

James Herriot, "All Creatures Great and Small"; Dr. Robin Cook, "Coma"; Oswald Wynd, "Ginger Tree"; Robert Ludlum, "Holcroft Covenant"; Ed McBain, "Goldilocks"; Laurence Sanders, "Second Deadly Sin"; J. Samson, "The Auctioneer"; T. Caldwell, "Captains and Kings"; J. Wambough, "The Choirboys"; also, B. Cavanna, "Diane's New Love"; K. Robertson, "If Wishes Were Horses"; A. Haily, "The Moneychangers"; P. Zindel, "My Darling, My Hamburger"; A. Walden, "My Sister Mike"; E. Kata, "Patch of Blue"; C. Samuel, "Run Shelley Run"; S. Hinton, "That Was Then, This is Now"; and, L. Uris, "Trinity"; Jr. Reiss, "Upstairs Room"; Coal Minors, "Loretta Lynn"; L. Lynn, "Daughter"; R. Pick, "Are You in the House Alone?"; J. Michener, "Hawaii"; Resume Service "Resumes That Get Jobs"; Kempt and Richard, "Metric System Made Simple"; M. Stewart, "Touch Not the Cat"; Anonymous, "Go Ask Alice"; B. Butler, "Gift of Gold"; H. Savitz, "Lionhearted."

Pitch Club

The Pitch Club met Sunday evening in the home of Mrs. E.T. Warnemunde.

Prizes were won by Mrs. Lloyd Behmer, Mr. and Mrs. J.G. Sweigard and Alfred Miller. Meetings will resume in September.

Meet for Picnic

The Clifton Burris and Sam Burris were among relatives and friends who attended a picnic Sunday at the Pilger Park to honor Sam Burris of Hawaii.

Sam leaves next month for Singapore. The Clifton Burris and Sam Burris were supper guests that evening in the Herman Topp home and visited in the Roger Vahle home in Pilger.

Two Years Old

Guests June 7 in the Mike Thompson home for Amy's second birthday were Mrs. Mildred Thompson, Battle Creek, Mo., and Mrs. LeRoy Plummer, Sholes, the Kevin Thompson family, Stanton, Mo., Dave Welch and Greg, Norfolk, and the Jim Preuner family, Sherri Thompson and Allen Warneke, all of Battle Creek.

Schluters Visit

The Al Schluter family spent the May 29 week touring Colorado and Wyoming.

They visited in the George Stahr home at Loveland, Colo., and with the Roger Mays at Comstock, Nebr. They also visited other relatives.

St. Paul's Lutheran Church

(G.W. Gottberg, pastor)
Thursday: Office hours, 9 a.m. to noon; women's Bible study, 2 p.m.; elders meeting, 8:30.
Friday: Office hours, 9 a.m. to noon.
Saturday: Office hours, 9 a.m. to noon.
Sunday: Sunday school and worship, 10:30.

Cars, Trucks Registered

WAYNE COUNTY CAR REGISTRATIONS

- 1978
Winside High School, Winside, Chev
William Claybaugh, Carroll, Ddg
William Lubberstedt, Wayne, Chev
1977
Grace Kinney, Wakarusa, Merc
Wayne Public Schools, Wayne,
Buck
Winside Dehy Corporation, Winside,
Ddg Pkg
Farmers Mutual of Nebr., Wayne,
Ed
David Draghu, Wayne, Chev
1977
Gerry Huribert, Wayne, Ply
Brian Lancaster, Wayne, Kaw
1976
Todd Jenkins, Carroll, Chev Pkg
1975
John Lempe, Wayne, Honda
Floyd Burt, Winside, Ford
Richard Milligan, Wayne, Merc
David Olson, Wayne, Honda
1973
Timothy Koll, Wayne, Chev
Marilyn Dowling, Randolph, Chev
Marie Lansing, Wayne, Chev
Sandra Bennett, Wayne, Merc
1972
Roger Schroeder, Winside, Chev
Pkg
Kennard Woodman, Hoskins, Ply
Kevin McCurtley, Wayne, Honda
1971
Mike Test, Wayne, Yarn
Shari Lawrence, Wayne, Ply
1970
Richard Reep, Wayne, Olds
1969
Terrence Jaeger, Winside, Ddg
Jerry Reep, Wayne, Chev
1967
Mark Lowe, Wayne, Chev Pkg
Martha Clauson, Wayne, Chev
John Felton, Wakarusa, Chev
1966
Marie Hagemann, Wayne, Ply
1964
Bill Fenske, Hoskins, VW
Matt Maloy, Wayne, Triumph
1962
Susan Bolton, Wayne, Pont
1961
William Holle, Hoskins, Chev Pkg

READ AND USE
WAYNE HERALD
WANT ADS

Bible classes, 9:30 a.m.; worship, 10:30.

Trinity Lutheran Church
(Leon DuBuis, pastor)
Sunday: Sunday school and Bible class, 9:30 a.m.; worship, 10:30.

United Methodist Church
(Al Ehlers, lay speaker)
Sunday: Sunday school, 10 a.m.; worship, 11.

Social Calendar
Thursday, June 15: Center Circle, Bernie Bowers.
Friday, June 16: SOS Club, Mrs. James C. Jensen.
Tuesday, June 20: Pitch Club, Vernon Hills.
Wednesday, June 21: Friendly Wednesday Club, Mrs. Florenz Niemann.

The Howard Iversens and the Bill Iversen family spent the weekend in Minden and toured Pioneer Village.

Mrs. Roger Bargestadt and family, Omaha, spent June 6-10 in the Alvin Bargestadt and Dave Miller homes. The children remained with their grandparents for this week.

The Andrew Manns visited the Earl Bordners in the Wisner Manor Saturday. Manns and the Dean, Janes visited in the Myron Petersen home at Laurel Sunday evening.

The Glen Olsons and the Lyle Samuelsons and Carl spent Sunday in the Randy Milnes home in Omaha to celebrate Mrs. Milnes' birthday.

Frank Wylie, Andersen, Mo., left Tuesday after spending the week in the Chester Wylie home. Joining them for supper Saturday were the Don Wylie and Don

Longnecker families. Rodney Diederichsen spent June 7-11 in the Don Gudenkauf home, Osmond. Supper guests Sunday in the Ivan Diederichsen home were the Roger Tacey and Michelle and the Don Gudenkaufs and Mark, all of Osmond, and the Rod Schwankes of Wayne.

The Lloyd Behmers returned home Friday evening after spending a week in the Keith Mason home at Columbia, Mo. The group spent June 4 at the Lake of the Ozarks.

RENT RINSEVAC
the professional do-it-yourself carpet cleaning system
SPECIAL RENTAL RATE OFFER
\$5 FOR 24-HOUR DAY
RINSEVAC cleans the way professionals do, at a fraction of the cost
Go Gambles
213 Main - Wayne, Nebraska

Want low-cost financing?

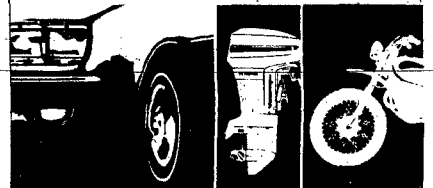

If you're thinking about buying a new or used car, or a boat and motor, motorcycle, camper, travel trailer, mobile home...

You should be thinking about fast, low-cost financing. From American Family. You don't have to be an American Family policyholder to qualify.

We can even pre-arrange the financing, so you can make that purchase with cash in hand. One call. One form. No hassle. It's the fast, easy, personal way...and it could save you some money. Call today!

Bill Woehler
Prof. Bldg.
112 W. 2nd Street
Phone: 375-4606



Get A
Beautiful
8 x 10

Living
Color
Portrait

88¢

Groups: 88¢ per person.

Babies-Children-Adults-Groups

Your baby's special charm captured by our specialist in child photography — just the gift for everyone in the family! All ages — family groups, too. Limit one special per person.

You'll see finished pictures — NOT PROOFS — Additional 8 x 10, 5 x 7 1/2, and wallet size available at reasonable prices.

McDonald's
June 14th - 15th
Wed. -
Thur.



PHOTOGRAPHERS HOURS:
Daily, 10 a.m. to 1 p.m. — 2 p.m. to 5 p.m.
Thursday, 10 a.m. to 1 p.m. — 2 p.m. to 5 p.m.

PUBLIC NOTICES BECAUSE THE PEOPLE MUST KNOW

Deadline for all legal notices to be published by The Wayne Herald is as follows: 5 p.m. Monday for Thursday's newspaper for 5 p.m. Thursday for Monday's newspaper.

PUBLIC HEARING MINUTES May 8, 1978 A Public Hearing was held at the City Hall concerning the application for Mud Block funds. Meeting was held at 4:00 p.m. One objection at the hearing and no objections or comments were voiced. (Publ. June 15)

NOTICE OF CREATION Notice is hereby given that the Mayor and Council of the City of Wayne, Nebraska, have by Ordinance No. 906, passed on May 30, 1978, created Street Improvement District No. 78.2. The outer boundaries of said District include the following described property:

Beginning at a point 20 feet East of and 21 feet South of the center of Section Thirteen (13), Township Twenty-six (26) North, Range Three (3), East of the 6th P.M., Wayne County, Nebraska; thence South 150 feet to a point, thence West parallel to the South line of Grainland Road, Wayne, Nebraska, 481 feet to a point; thence North 150 feet to a point; thence West 33 feet South of and parallel to the center line of Grainland Road, to a point on the West line of Lot One (1), Block One (1), Knoll's Subdivision, City of Wayne, Nebraska, as extended South; thence North along the West line of said Lot 1, as extended to the Northwest corner of Lot 2, said Block 1; thence East along the North line of said Lot 2 and Lot 2, Block 2, said addition, and the South line of Lots 11, 10, and 9, Will-Citt Subdivision, Wayne, Nebraska, to a point on the East

line of said Lot 9; thence South approximately 30.5 feet to a point; thence East approximately 30.5 feet to a point; thence East approximately 578.5 feet to a point on the East line of Lot 7; Taylor and Wachob's Addition to the City of Wayne, Nebraska; thence South along the East line of said Lot 7 as extended South to the South line of Grainland Road; thence West to the point of beginning. Within said district, improvements shall be constructed consisting of grading, curbing, guttering, concrete paving and construction of other necessary appurtenant improvements. Said improvements shall be made on and along the following described streets within said district:

Grainland Road from the East line of Blaine Street to the West line of Maple Street. Said improvements are to be made in accordance with plans and specifications prepared by the special engineer of the City and approved by the Mayor and City Council. Said improvements shall be made at public cost; but the City shall levy special assessments on the property within the District especially benefits thereby as provided by law.

If record owners representing more than 50 percent of the front footage of the property directly abutting on, or more within said district shall file with the City Clerk within twenty days after June 1, 1978, the first publication of this notice, written objections to the creation of said district, said objections are not filed against the District in the time and manner aforesaid, the Mayor and Council for the City of Wayne, shall forthwith cause such work to be done and such improvements to be made, and shall contract therefor.

Bruce Merdhorst, City Clerk (Publ. June 1, 8, 15)

NOTICE OF PROPOSED USE HEARING - REVENUE SHARING FUNDS Notice is hereby given that the Mayor of the City of Wayne, Nebraska, will hold a Proposed Use Hearing for Revenue Sharing Funds of the City of Wayne's 1978-79 Fiscal Year on Tuesday, June 27, 1978 at 7:30 p.m. in the Council Chambers in City Hall. At this time the citizens of Wayne will be given an opportunity to make written or oral comments and suggestions regarding possible uses of the City's Revenue Sharing Funds. The City of Wayne expects to receive \$30,345 from Revenue Sharing during the fiscal year 1978-79. The amount of \$14,107.88 currently in the Revenue Sharing Account. F. B. Decker, Mayor City of Wayne, Nebraska (Publ. June 15)

HOSKINS VILLAGE BOARD PROCEEDINGS May 30, 1978 The Village Board met in regular session at 7:30 p.m. at the City Hall. Board members present were Scheurich, Opler, Ave and Miller. Absent, Patterson. Notice of the meeting was given in advance. All board members acknowledged notice of meeting. All proceedings heretofore shown were taken as the convened meeting was opened to the attendance of the public.

Results of the city election were: Kenneth E. Elkins 46 John Scheurich 46 James A. Miller 59 Lloyd Ave 59 Elkins, Scheurich and Miller were sworn into office to serve a four year term.

Complaints were received about unused vehicles parked along the street which interfere with vision of intersections. The county deputy is to check these vehicles. A city vehicle was discussed. The cost of fixing the old ambulance will be checked and also the availability of a surplus equipment vehicle. A city test will on the Herman Opler property. Carried. Ordinance 1978-1 was presented. It is an ordinance authorizing the issuance of Refunding Bonds of the Village of Hoskins, Nebraska, in the principal amount of One Hundred Ten Thousand Dollars; Prescribing the Form of said Bonds and sinking fund and for the Levy of Taxes to pay said bonds; Providing for the sale of the Bonds; Authorizing the Delivery of the Bonds to the purchaser; Providing for the Disposition of the Bond proceeds and ordering the ordinance published in Pamphlet form.

NOTICE TO CREDITORS UPON FORMAL APPOINTMENT OF PERSONAL REPRESENTATIVE County Court of Wayne County, Nebraska. Estate of Ella McFadden, Deceased. Notice is hereby given that Darrell McFadden whose address is Nebraska 68771, has been appointed Personal Representative of this estate. Creditors of this estate must file their claims with this Court on or before August 10, 1978, or be forever barred. (s) R. Bruce Henning County Judge (Publ. June 8, 15, 22) 5 clips

NOTICE TO CREDITORS UPON FORMAL APPOINTMENT OF PERSONAL REPRESENTATIVE County Court of Wayne County, Nebraska. Estate of V.G. McFadden, Deceased. Notice is hereby given that Darrell McFadden whose address is Nebraska 68771, has been appointed Personal Representative of this estate. Creditors of this estate must file their claims with this Court on or before August 10, 1978, or be forever barred. (s) R. Bruce Henning County Judge (Publ. June 8, 15, 22) 8 clips

NOTICE OF INFORMAL PROBATE AND NOTICE TO CREDITORS Case No. 4381. County Court of Wayne County, Nebraska. Estate of Katherine F. Otte, Deceased. Notice is hereby given that on June 2, 1978, in the Wayne County Court, the Registrar issued a written Statement of Informal Probate of the Will of said Deceased and that Florence Geewo and Evelyn Gathie, whose address is Rural Route 1, Wakefield, Nebraska and Rural Route 2, Wayne, Nebraska (a) has been appointed Personal Representative of this estate. Creditors of this estate must file their claims with this Court on or before August 22, 1978, or be forever barred. (s) Luverna Hilton Clerk of County Court Charles E. McDermott, Attorney (Publ. June 8, 15, 22) 10 clips

Every government official or board that handles public moneys, should publish at regular intervals an accounting of it showing where and how each dollar is spent. We hold this to be a fundamental principle to democratic government.

NOTICE OF INFORMAL PROBATE AND NOTICE TO CREDITORS Case No. 4378. County Court of Wayne County, Nebraska. Estate of Lillian J. Kenny, Deceased. Notice is hereby given that on May 30, 1978, in the Wayne County Court, the Registrar issued a written Statement of Informal Probate of the Will of said Deceased and that Merlin Edmond Kenny and Ruel Reule 2, Wayne, Nebraska 68773 has been appointed Personal Representative of this estate. Creditors of this estate must file their claims with this Court on or before August 14, 1978, or be forever barred. (s) Luverna Hilton Clerk of County Court Olds, Swarts and Enns, Attorney (Publ. June 1, 8, 15) 6 clips

WAYNE COUNTY BOARD OF COMMISSIONERS PROCEEDINGS Wayne, Nebraska June 6, 1978 The Wayne County Board of Commissioners met per adjournment with all members present. The minutes of the preceding meeting were read and approved. Advance notice of this meeting was published in the Wayne Herald, a legal newspaper, on June 1, 1978. A motion by Eddie to accept the resignation of Fred Rickers as the Wayne County School Superintendent and the second by Burt. Roll call vote resulting in all Ayes. Motion made by Burt and seconded Eddie to appoint Loren Parks as part-time Wayne County School Superintendent to complete the term of Fred Rickers; the salary to be \$500.00 per month. Roll call vote - all Ayes. Motion made by Beiermann to allow the Continental Telephone of Nebraska to bury telephone cable between Sections 31 and 32 in Township 25, Range 5. Motion was seconded by Burt. Motion carried. Robert Hamman, director of the Mid-Elkhorn Valley Council of Governments, met with the Board to present the grant application for the third year funding from LEA for out Countywide Law Enforcement. The motion was made by Burt to approve the third year funding application which calls for the County's share going to \$22,128.00 and to raise the Village's share of this from \$1 to \$1.25 per capita per month. Motion was seconded by Eddie. Roll call vote: Burt, Ave; Eddie, Ave and Beiermann, Ave. The following officers' reports of fees collected during the month of May are remitted to State and County Treasurers were approved as follows: N.F. Weible, County Clerk - \$2,768.80 Joann Oslander, CDC - \$189.25 Don Weibers, Sheriff - \$63.00

NOTICE OF MEETING The Wayne County Board of Commissioners will meet on Tuesday, June 20, 1978 at the Wayne County Courthouse from 9 a.m. until 4 p.m. The agenda for this meeting is available for public inspection at the County Clerk's office. Norris F. Weible County Clerk (Publ. June 15)

NOTICE OF MEETING The Wayne County Board of Commissioners will meet on Tuesday, June 20, 1978 at the Wayne County Courthouse from 9 a.m. until 4 p.m. The agenda for this meeting is available for public inspection at the County Clerk's office. Norris F. Weible County Clerk (Publ. June 15)

The following claims were audited and allowed. Warrants to be ready for distribution on June 16, 1978. GENERAL FUND Balance Salaries Eastern Nebr. Telephone Co. May services Nebr. Ass'n of Co. Clerks, ROD, ass'n dues Norfolk Office Equipment, supplies, new equip, maint. Redfield & Co., Inc., supplies Wayne Book Store, supplies RC Both Enterprises, maps and plats

Table listing various suppliers and their amounts, including Cobs Mtg Co., Omaha Printing, Eastman Kodak Co., Western Publishing Co., Duane W. Schroeder, legal services, Consol. Eng. Architects, engineering, millage, etc., Dean's Farm Service, gas, N & M Oil Co., gas, Fredrickson Oil Co., maintenance of equipment, M & S Oil Co., maintenance of equipment, Motorola, Inc., maintenance, Winslow Motor, maintenance of equipment, Don Weible, convention expenses, First National Agency, boiler insurance, City of Wayne, Tights, water & sewer, Wayne Refuse Service, May trash, M & S Oil Co., supplies, Mid-Am. Research Che. Corp., supplies, First National Agency, boiler insurance, Husker Concrete & Gravel, concrete, Logan Valley implement, maintenance of equipment, KTCB, ads, Blue Cross Blue Shield, group insurance - June premium, Schmoede's, Inc., repairs, Dr. Scott & Pennebacker, autopsy, Denthal Clinic, services rendered, Morning Shopper, supplies, Xerox Corp., maintenance, Xerox Corporation, new equipment, Xerox Corp., machine rental, Wilma M. Schroeder, cleaning service, Eastman Kodak Co., maintenance of equipment, REGIONAL CENTER FUND, COUNTY ROAD FUND, Salaries, Allied Lumber & Supply, supplies, Corvett Auto Co., repair, Corvett Derby Service, repair, Diers Supply, supplies, Fredrickson Oil Co., tire repair, Mo. Valley Mchry, repairs, Ron's Radio, repairs, Schmoede's, Inc., repairs, Thises Bruiglan, Inc., repairs, Wayne Auto Parts, repairs, Dean's Farm Service, gas & oil, M & S Oil Co., oil, Merchant Oil Co., oil, Nebr. Sand & Gravel, gravel, Doonan Trucking & Equipment, truck, Husker Concrete & Gravel, concrete, Wheeler Div. St. Regis Paper, material, Winney Brdg Construction, contract work, City of Wayne, Tights, water & sewer, Consol. Eng. Arch. Inc., monthly payment, Corvett Auto Co., repair, Wayne County Public Work Dist., may services, Graham Brake, repair, Mo. Valley Mchry Co., repairs, Region IV Services, flags, Wayne Auto Parts, repairs, Winslow Motor, repairs, M & S Oil Co., gas, oil, Stenwall's Service, gas, Mid West Brdg & Construction, gravel, Wheeler Div. St. Regis Paper, culverts, Doonan Trucking & Equipment, truck, Husker Concrete & Gravel Co., gravel, Mid West Brdg & Construction, gravel, Nebr. Sand & Gravel Co., Inc., gravel, INHERITANCE TAX FUND, General Fund, transfer of funds, Regional Center Fund, transfer of funds, Meeting was adjourned. N.F. Weible, County Clerk (Publ. June 15)

SHORT NOTICE Saturday, June 16 For Your Dancing Pleasure 8:30 p.m. - 12:30 a.m. RON'S Steakhouse Carroll, Nebraska

Canvas Tote Bag FREE Personalized - Roomy 14" x 16" with handy outside pocket - Heavy Duty, machine washable canvas Natural beige with navy stitching, straps and monogram Carry in-hand or over-the-shoulder. For saving \$500

The State National Bank and Trust Company Wayne, NE 68787 • 402-375-1130 • Member FDIC Main Bank 122 Main • Drive-In Bank 10th & Main

ADVERTISMENT FOR BIDS The City of Wayne, Nebraska will receive bids for construction of street improvement District Nos. 78.1, 78.2 and 78.3, until 8:00 p.m., June 27, 1978, at the office of the City Clerk, City Hall, Wayne, Nebraska. At this time all bids will be opened and publicly read aloud. Enumerated below are the estimated quantities of work to be done in each separate district, whose STREET IMPROVEMENT DISTRICT NO. 78-1: 4,830 Sq. Yds. 6" P.C. Concrete paving 2,730 L.F. 6" Integral Curb 93 L.F. Header to be constructed 20 Sq. Yds. 6" Concrete to be constructed STREET IMPROVEMENT DISTRICT NO. 78-2: 3,480 Sq. Yds. 6" P.C. Concrete paving 1,900 L.F. 6" Integral Curb 62 L.F. Header to be removed 74 L.F. Header to be constructed 35 L.F. 18" RCP Storm Sewer to be constructed 2 Ea. Junction Boxes to be constructed 3 Ea. Inlets to be constructed STREET IMPROVEMENT DISTRICT NO. 78-3: 1,030 Sq. Yds. 6" P.C. Concrete paving 500 L.F. 6" Integral Curb 120 L.F. Header to be constructed 315 Sq. Yds. 6" Concrete to be removed 1 Ea. Manhole to be adjusted to grade 1 Ea. Special Inlet to be constructed 45 L.F. 24" RCP Storm Sewer to be constructed 295 L.F. 18" RCP Storm Sewer to be constructed 6 L.F. 12" RCP Storm Sewer to be constructed 1 Ea. Inlet to be constructed The bids will be an aggregate bid for all work to be performed in the combined districts broken down in such a manner as will accurately reflect unit prices for estimated quantities set out hereunder. Thickness and types of paving, details of integral curb, materials to be used, methods of laying, and full details of construction for this project are given in the plans and specifications. Contract documents, including plans and specifications, are on file in the office of the City Clerk, Wayne, Nebraska. Copies of these documents for personal use may be obtained from the special Engineer, Bruce Gilmore & Associates, Inc., Box 565, Columbus, Nebraska, 68601, upon payment of \$20.00, \$10.00 of which will be refunded if returned in good condition, within 10 days after the letting. Each bid shall be accompanied in a separate sealed envelope by a certified check, drawn on a bank which is insured by the F.D.I.C., or a bid bond in a sum not less than 5 percent of the amount bid, made payable to the City Treasurer, Wayne, Nebraska, as security that the bidder to whom the contract will be awarded will enter into a contract to build the improvements. Checks or bid bonds accompanying bids not accepted shall be returned to the bidder, in accordance with this notice, the bidder will turn over bond in the sum as hereinafter provided. A performance and maintenance bond in an amount equal to the percent of the contract price shall be furnished by the successful bidder. Bids shall be withdrawn after the opening of bids without consent of the City of Wayne, Nebraska, for a period of 30 days after the scheduled time of opening bids. The City reserved the right to reject any and all bids and to waive any technicalities or informalities in bidding. Dated at Wayne, Nebraska, this 30 day of May, 1978, by order of the Mayor and City Council of Wayne, Nebraska. F. B. Decker, Mayor ATTEST: Bruce Merdhorst, City Clerk (Publ. June 8, 15)

3 DAYS LEFT Going on Now! Once-a-year savings on some of our best and most popular appliances. National Frigidaire Week ENDS MONDAY-JUNE 19TH ALL FRIGIDAIRE SALES PRICED SAVE UP TO \$125 REFRIGERATORS-RANGES WASHERS---DRYERS DISHWASHERS-FOOD FREEZERS KUGLER KUGLER ELECTRIC'S BIGGEST SALE OF THE YEAR BUY NOW-SAVE BIG-BIG DOLLARS KUGLER ELECTRIC 106 Main St. Wayne, Nebr. Ph. 375-1112 We Service What We Sell Russ Tiedtke, Owner

Show Freedom of Nation Seminar Pictures

The Golden Rule Club met Thursday with Mrs. Quinten Erwin as hostess. Members went sight seeing with Mrs. Allan Rastede of Allen when she showed recent pictures of the

Seminar of Freedom of Our Nation at Valley Forge, Pa. "My Favorite First Vegetable from the Garden" was roll call. Ten members were present. Discussions were held on future projects for the summer months.

New Pastor
Installed as the new pastor Sunday afternoon for the St. Paul's Lutheran Church in Concord was the Rev. Fredrick Cook.

He was ordained June 4 at the Trinity Lutheran Church in Danville, Ill.
Pastors taking part in the service were the Rev. Ronald Holling, Wakefield; the Rev. G.W. Gottberg, Winside; the Rev. Wayland, South Sioux City, and the Rev. Paul Friedrich of Martinsburg.

The St. Paul's Sunday school children sang and refreshments followed the service.

Pleasant Dell
The Pleasant Dell Club met Thursday with Mrs. Marvin Reinkink as hostess. Nine members and three guests were present.

Those guests attending were Mrs. George Valters, Mrs. Alma Weiershauser, Wayne, and a former member, Mrs. Martin Hanson, Carroll. Roll call was answered with "A Special Wedding."

Annice Carlson had entertainment with two pencil games. The July 13 meeting will be a trip to Ponca State Park.

Wyoming Visit
The Roy Pearsons spent the week of June 1 through the 7 in the Don Peppers home at Evansville, Wyo.

The evening of June 3 they attended their granddaughter's wedding. She is Debbie Pearson who was married to Kenny Northrop, also of Evansville, Wyo. The couple was married in their own home which they had built and furnished.

Also attending the wedding was Florence Jenkins from Winside.

Texas Guests
Visiting relatives in Concord, Wayne, Wakefield and Dixon Thursday through Sunday were the Wymore-Goldbergs-of-Fort Worth, Tex. and the Larry Smiths, Michelle and Jeremy of

San Antonio, Tex.
The Goldbergs were overnight guests at Eshler Petersons and the Smiths stayed at Tekla Johnsons.

For supper on Saturday the Goldbergs and Smiths joined the Doug Kries, Brent Johnson, Bruce Johnson, the Ernest Swansons, and the Regg Swansons at the Evert Johnson home.

Both families joined Clara Swanson, Esther Peterson, Tekla Johnson, Evert Johnsons, Carla and Bruce, the Doug Kries, the Ernest Swansons and Ann and relatives for Sunday dinner in the Julius Peterson home at Stanton, Ia.

In the afternoon they all attended the 50th wedding anniversary of the Luther Goldbergs of Essex, Ia., which was held at the Nyman Lutheran Church.

Weekend Visitors
Weekend guests in the Norman Anderson home were the Albert Siecks of Lincoln. Joining them for Sunday dinner were Glennis Anderson and Doug Tretow of Kearney, and Mrs. Jerry Stanley of Dixon.

The Ted Petersons of Sturgeon Lake, Minn., and Mrs. Arthur Johnson of Moose Lake, Minn., spent the weekend in the Clifford Fredrickson home.

Pam Johnson of Lincoln spent the weekend with the Marlen Johnsons and Denise Erickson also of Lincoln spent the weekend with the Keith Ericksons.

Concordia Lutheran Church
(David Newman, pastor)
Thursday: Lutheran Church Women, 2 p.m.

Saturday: Invitation to attend dedication program of new resident buildings, Bethpage Mission, Axtell, Nebr., 2 p.m.
Sunday: Sunday school and Bible classes, 9:30 a.m.; worship, 10:45.

Wednesday: NE Nebraska
Sunday school convention, Redeemer Lutheran Church, Hooper, Nebr., 9:30 a.m. to 3:15 p.m.

St. Paul's Lutheran Church
(Fredrick Cook, pastor)
Sunday: Worship, 8:30 a.m.; Sunday school, 9:30.

Thursday: Ladies Aid, 2 p.m.

Evangelical Free Church
(Detlov Lindquist, pastor)
Sunday: Sunday school, 10 a.m.; worship, 11; Service at

Saucor Nursing Home, Laurel, 1:30 p.m.; prayer time, 7:15; evening service, 7:30. This will be the farewell Sunday for Pastor and Mrs. Lindquist.

Monday-Saturday: National Free Church conference, Minneapolis, Minn.

The Dwight Johnson family and Mrs. Arthur Johnson were guests Friday evening in the Melvin Puhman home in honor of their wedding anniversary.

Mrs. Harold Johnson, Tash and Steve of Omaha spent several days in the Kenneth Klausen home last week.

A Sunday dinner guest of Mrs. Raymond Erickson was Mrs. Geneva Anderson of Minneapolis, Minn.

Guests in the Jim Nelson home for Sunday dinner in honor of Danny's birthday were the Erick Nelsons, the Arthur Johnsons, Mary Nelson and James Wordekemper, Norfolk.

Women's Welfare

The Concord Women's Welfare Club met the afternoon of June 7 with Mrs. Ivar Anderson as hostess. For roll call the 14 members present showed their wedding picture or told something about their wedding.

Mrs. Winston Wallin was a guest. The group read the Collect and the minutes were read.

The club hospital equipment was discussed and a love gift was sent to Ellie Rees. Lucille Olson read a letter from a former member, Mrs. Ethel Fisher.

One birthday cake was reported. A flower pencil game was led by Mrs. Bob Anderson for entertainment.

The July 5 hostess will be Mrs. Clarence Pearson.

Post Masters

Attending the National Association of Post Masters State Convention of the United States June 5 through 7 were the Norman Andersons.

It was held at the Marina Inn in South Sioux City. Anderson is the State Membership Chairman.

LCA Meet

The Glen Magnusons were in Omaha June 5 and 6 where Mrs. Magnuson attended the Lutheran Church of America Synod Board meetings. They were held at the Church House.

The evening of June 5 they were entertained at a cook out meal for the staff members of Dr. and Mrs. Rubeen Swanson's home. Dr. Swanson is the Nebraska Synod President of LCA.

Mrs. Roy Hanson, Verlin and Monica, and Mrs. Phyllis Dirks attended the graduation of Marvin Hanson the evening of June 5 at the Civic Auditorium in Omaha. Following commencement they were luncheon guests in the Charles Hanson home.

The Roger Hansons, Lorane and Kyle of Manilla, Ia., visited Paul Hanson and other relatives in Concord June 4. They also visited Mrs. Thelma Hanson at the Saucer Rest Home in Laurel.

Visiting Mrs. Hanson June 1 were Mrs. Charles Hanson, Marvin and Rachell of Omaha, and Mrs. Dessie Decker and Linda Hanson of Meno, Okla. They also visited other Hanson relatives in Concord.

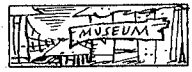

The oldest museum in the world is the Ashmolean Museum in Oxford, England, built in 1691!

Hearing Loss Is Not A Sign Of Old Age

Chicago, Ill.—A free offer of special interest to those who hear but do not understand words has been announced by Beltone. A non-operating model of the smallest Beltone aid of its kind will be given absolutely free to anyone answering this advertisement.

Send for this model, put it on and wear it in the privacy of your own home. While many people with a hearing loss will not receive any significant benefit from any hearing aid, this free model will show you how tiny hearing help can be. It is not a real hearing aid, and it's yours to keep, free. The actual aid weighs less than a third of an ounce, and it's all at ear level, in one unit.

These models are free, so we suggest you write for yours now. Again, we repeat, there is no cost, and certainly no obligation. Thousands have already been mailed, so write today to Dept. 2201, Beltone Electronics, 4201 W. Victoria St., Chicago, Illinois 60646.



New Water Well

THE CITY of Dixon is continuing its long term improvement project by installing a new water system in the community. The \$95,000 water project is funded through a government grant of \$47,000 and a FHA loan according to Mayor John Young. The project will include new main lines, hydrants and a municipal well now being installed. Here Mark Miller, Doug Schwarten, and Kenneth Salmon are in the process of drilling the main well.

For all he is, he gets just Father's Day JUNE 18



Make your play for a sports-filled Summer! We've a whole group of cool classic looks to suit your sporting life stylishly...comfortably! Team up golf slacks and tees, tennis shorts and tops...in no-fuss light-weight Summer fabrics!

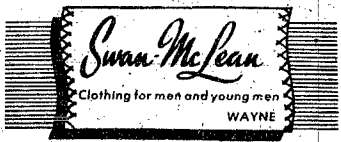

"Beef for Father's Day"
Tender - Juicy
SIRLOIN STEAK
\$1.99 Lb.
Open Monday thru Friday - 8 a.m. to 6 p.m.; Saturday - 8 a.m. to 1 p.m.

Fresh Ground
BEEF CHUCK
\$1.19 Lb.

Norbest Grade "A"
TURKEYS (7-9 Lb. Avg.)
89¢ Lb.

Wrights Bar-B-Q
LIQUID SMOKE
49¢
Meadow Gold
ICE CREAM
(5 Qt. Bucket) \$2.49

Choice **BEEF ROASTS**
Arm Cuts \$1.09 Lb.
No. 7 Cuts 93¢ Lb.

PRICES EFFECTIVE JUNE 15-17.
JOHNSON'S FROZEN FOODS
Phone 375-1100 Wayne 116 West Third

Baby, put a charge in your life!

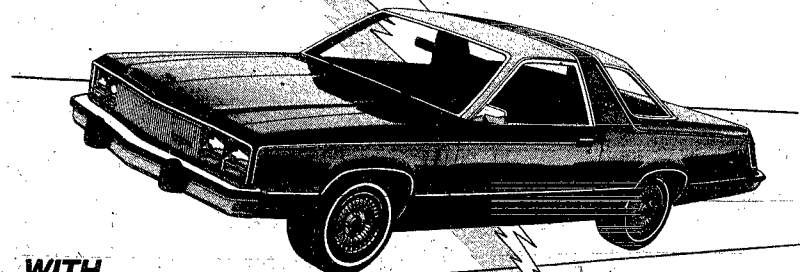

MERCURY ZEPHYR Z-7

Meet the new personal car in town: Mercury Zephyr Z-7 Sport Coupe. Energy-engineered for space and mileage. High-voltage styling. Sexy, slant-z roof. Bucket seat cockpit, wrap-around taillamps. A sticker price that will give you a charge! Z-7 leads a line of Zephyr 2-doors and 4-doors. Plus wagons with more cargo space than Aspen or Volare, based on EPA interior volume index. Mercury Zephyr has an EPA rating equal to the best in its class. Why look at anything else when you can go to the head of the class!

EPA* **33** HWY **23** CITY

*With standard 2.3 liter engine and manual transmission. Your actual mileage may vary depending on your car's condition, optional equipment and how and where you drive. Wagon ratings lower.

Z-7 leads a line of energy-engineered beauties!

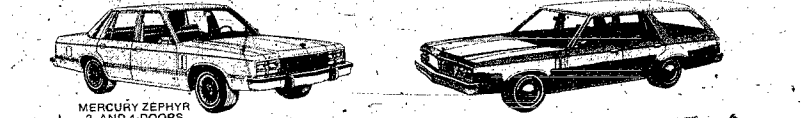

ROY WARD
FORD-MERCURY
119 East Third Street Phone 375-3780



WHAT MAKES DAD'S DAY SPECIAL? These Food Specials!

FROZEN CHICKENS Lb. **39¢**
(While quantities last)

MORRELL ALL MEAT FRANKS \$1.05
Reg. or Beef
LB. PKG.

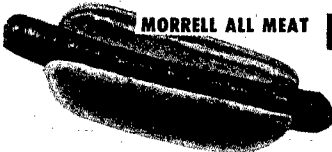

BACON
HORMEL RANGE **\$3.29**
2 Lb. Pkg.



BEEF LIVER
69¢ LB.

Homemade **PORK SAUSAGE** **79¢** Lb.

Chicken **NECKS & BACKS**
10¢ Lb.

Chicken **GIZZARDS**
69¢ Lb.

Chicken **DRUM STICKS**
69¢ Lb.
(While Quantities Last)

PRICES EFFECTIVE THROUGH SUNDAY, JUNE 18

HORMEL **LITTLE SIZZLERS** OR SWIFT BROWN & SERVE **LINK SAUSAGE** YOUR CHOICE **89¢** Pkg.

Morrell **BRAUNSCHWEIGER** **69¢** Lb.

3 Oz. Jar

NESTEA

\$1.98



(We Reserve the Right to Limit)

Birthdays Drawing
Thursday at
8:15 p.m.
1034 Main



STORE HOURS:
Open Every Evening
Except Saturday & Sunday
Until 8:30 p.m.
Sunday from
10 a.m. to 5 p.m.
Open Thursday Evening Til 9

Phone 375-2440

ARNIE'S
Just Across from the College Campus

Peter Piper **PEACHES** **2/99¢**
2 1/2 Size

CHARCOAL BRIQUETTES 10 Lb. Bag **\$1.49**

Monarch **MUSHROOMS**

4 Oz. Can
Pieces & Stems **2/89¢**

BUTTERTOP BREAD



2 1 1/2-lb. loaves **89¢**

Shurfine **SUGAR**
10 Lb. Bag **\$2.19**

Bath Size **DIAL SOAP**
78¢
8" Off Pak

Robin Hood **FLOUR**
25 Lb. Bag **\$3.49**



Planters 12 Oz. Can
MIXED NUTS
\$1.59



Shurfine 303 Size
CORN
4/\$1

FREEZER-SIZED SAVINGS ON FROZEN FOODS

Shurfine Frozen **LEMONADE**
7 6 Oz. Cans **\$1**

COKE 6 Pak Cans **\$1.19**

Shurfine 303 Size
GRAPEFRUIT SECTIONS
2/79¢

Sara Lee Frozen **COFFEE RINGS**
4 Varieties **79¢** Ea.
Reg. 99¢

ALUMINUM FOIL
25 Ft. Roll **29¢**



CHARMIN TISSUE
4 Pak **89¢**

Shurfine Early Harvest **PEAS**
4/\$1
303 Size



California **CANTALOUPE** **3 FOR \$1**

California **BING CHERRIES** **98¢** Lb.

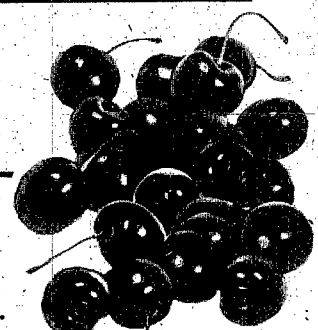

PAMIDA and GIBSON'S

DISCOUNT CENTER

Our Big 5 Day Mid-Summer

Discount SALE



OUR ENTIRE STOCK OF MENS \$4 & \$5 DRESS, SPORT & KNIT SHIRTS ON SALE NOW FOR

2 \$7 FOR 7

MENS KNIT SHIRTS...handsome group, polyester and cotton blend. 3 and 4 button front plackets, short sleeves and collar. Stripes or solids. Sizes S to XL.

MENS SPORT SHIRTS...polyester and cotton blends, many sharp styles to choose from. Solids and prints. Sizes 14 1/2-17.

MENS DRESS SHIRTS...exciting styles to choose from in bold prints or solids. Sizes 14 1/2 to 17.

RIGHTY MATCH LIGHTERS, NOW

3 FOR \$1



Disposable butane lighter with visible fuel supply and adjustable flame. Four colors.

QUALITY TUCKER ICE CUBE TRAYS

2 \$1 FOR 1

Deluxe heavy duty. Ice blue color. 84/2.

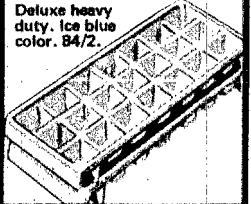

EVEREADY 6 VOLT BATTERY

96¢



Standard lantern and lighting battery. Spring terminal. No. 509.

ICE TEA GLASSES

6 FOR \$1

Spearmint or Spicy Brown colors. 16 ounce size!

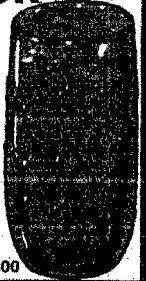

74 ounce Matching Pitcher...\$1.00

SHELL NO-PEST STRIP INSECTICIDE

136



Kills flies and mosquitoes indoors.

10 LB. CHARCOAL

96¢

Finest quality fast lights.



RAID HOUSE & GARDEN BUG KILLER

139

Non-toxic to humans and pets. From Johnson Wax. 13 1/2 ounces.



Advertising Supplement to:

ILLINOIS — Carlinville Preview; Dixon Telegraph; Highland New Leader; Chronicle Herald; Penny Saver; Rantoul Press; Casey Daily Reporter; Robinson Daily News; Breeze Courier. IOWA — Algona Reminder; Boone County Shopping News; Carroll Daily Times Herald & Carroll Shoppers Guide; Decorah Newspaper; Waukon Newspaper; Denison Bulletin; Forest City Shopper; Hampton Chronicle and Times; Shelby County Shopper; Buchanan County Reminder; Record Herald & Indiana Tribune; Bonanza Shopper; LeMars Rocket; DeWitt Observer & Jackson Sentinel; Muscatine Journal; Osceola Daily Register; Weekly Times; Spencer Daily Reporter & The Cash Finder; Webster City Daily Freeman; Waukon Democrat. KANSAS — Chanute Tribune & S.E. Kansas Weekly; Emporia Gazette; Miami Republican or Western Spirit; Parsons Sun; Pittsburg Morning Sun; Wellington Daily News; Winfield Daily Courier. MICHIGAN — Ironwood Daily Globe; Houghton Daily Mining Gazette. MINNESOTA — Tribune & Penny Pincher; Lakeland Shopper; The Brainerd Daily Dispatch & Brainerd Daily Shopper; Cloquet

Billboard; Crookston Valley Shopper; Becker County Record; Fairmont Daily Sentinel & Ad-Visor; Fergus Falls Daily Journal; Hibbing Tribune; Shoppers Guide; The Star Herald; Tri-Stat Shopper; Monticello Daily Reminder; Morris Sun; New Ulm Daily Journal; The Free Star; Red Wing Republican Eagle; Redwood Livewire; The St. James Plaindealer & Courier; Mesabi Daily News; Wadena Pioneer Journal & P.J. Quad County Intercom; Waseca Journal & Waseca Shopper; West Central Daily Tribune; Windom Shopper; Winona Shopper. MONTANA — Sidney Herald. NEBRASKA — Alliance Daily Times Herald; Beatrice Daily Sun - Sun Advertiser & Sunland; Blair Enterprise; The Crete News; Daily Citizen; Lexington Clipper; Seward County Independent; Wayne Herald; Wisner News Chronicle; Pilger Herald; Emerson Tri-County; Cedar Co. News; Laurel Advertiser. NORTH DAKOTA — Graton Record & Cavalier Chronicle; Jamestown Sun; Valley City Times Record; Wahpeton Daily News; Williston Herald. SOUTH DAKOTA — Brookings Daily Register; Huron Daily Plainsman; Broadcast Press; Watertown Public Opinion; Advisor. WYOMING — Cody Enterprise; The Douglas Budget; Gillette News Record; Green River Star; The Jackson Hole News; Wyoming State Journal & Lander Sun; The Rocket Miner; Daily Times; Saratoga Sun; Sheridan Press; Torrington Telegram; Northern Wyoming Daily News.

Just in time for Father!

**FOR THE MATURE MAN...
BRAIDED FASHION JEANS**

946

Poly and cotton blended brushed denim. Gentlemen cut for the mature man. 1 front pockets, decorative hip pockets.
Sizes 32 to 42

**GIFT IDEA...
MENS POLYESTER DRESS SLACKS**

788

Solid colors in a subtle textured weave double knit. Machine-washable, no iron of course. Ban-Roll waistband. Sizes 29 to 42. Hurry in for this fantastic value!

MENS COLORED UNDERWEAR

2 \$3 FOR 3

T-shirts or briefs. Polyester and cotton blend. 2-tone trim, low-rise brief, snug fit neckband on shirt

**FATHERS DAY
SUNDAY
JUNE 18TH**

MENS & BOYS PADDED COLLAR BASKETBALL OXFORDS

396

Top quality canvas, low cut style basketball oxfords. Navy or rust. Sizes 6-12 and 2-6.

DICKIES COVERALLS AT BIG SAVINGS

988

Cool, comfortable polyester and cotton poplin. 6 roomy pockets. 2-way zipper. Shape set, soil release



A Rain Check will be issued upon request on an altered item not a valuable due to an unforeseen reason at the time of purchase & Gibson's will notify you when the item is received or will sell you a comparable item at a comparable price. Satisfaction guaranteed always.

NYLON OR ORLON DRESS SOCKS

2 \$4 FOR 1

3-ply nylon reinforced toe and heel. In 4 colors. Sizes 10-13.
Orlon dress socks in 5 colors. Sizes 10-13.
Now both sale priced!

MENS AND BOYS SUEDE AND NYLON JOGGER

688

Lightweight athletic shoes. Padded and lined for exceptional comfort. Rugged action soles.
Mens 6 1/2 to 12
Boys 2 1/2 to 6.

YOUR SATISFACTION IS ALWAYS GUARANTEED

**BAN
LON**

**FATHERS
DAY
SUNDAY
JUNE 18TH**



SENSATIONAL SHIRT SALE JUST IN TIME FOR FATHERS DAY

**MENS SHORT SLEEVE BANLON
KNIT SHIRTS**

Neat, classic collar and placket Banlon knits. Tripping on collar and placket. Button-through pocket. Solids or stripes. S-XL.

4⁸⁸

**MENS LONG SLEEVE QIANA
SHIRTS, NOW**

Soft, silky Qiana nylon by Klopman Wear for sport or dress. Solid white, blue, tan or maize. Sizes S to XL.

6⁸⁸

**MENS LONG SLEEVE PRINT
SPORT SHIRTS**

65% acetate and 35% nylon blend. Bold, new geometric prints. Perfect for casual wear. Sizes S XL.

5⁸⁸

**MENS LONG SLEEVE PLAID
WESTERN SHIRTS**

65% polyester and 35% cotton blend. Full pearlized snap button western shirts. Double yoke front and back. 14 1/2-17.

6⁸⁸

Our Gigantic Mid-Summer Discount DAYS!

**20%
OFF**

**MENS TIMEX
WATCHES**

That's right, save a big 20% and give Dad one of the best presents on his special day! Many styles sale priced!



**MENS AMITY
LEATHER
BILLFOLDS**

5⁹⁷

Tri-fold, Identifier or Director styles. Black or brown. All leather.

AMITY



**3 PIECE VINYL
LUGGAGE SET**

39⁸⁸

Tough, 60 gauge expanded vinyl. Fleco molded front panel design. Newly designed handle. Metal bell studs. Lock cover with buckle. Color coordinated interior. Adjustable shoulder strap on tote. American made rugged corrugated steel frame. Tote, 22" carry all, 24" Jr. pullman. Blue or Tan.

**ENGLISH LEATHER
AFTER SHAVE
LOTION**

2⁹⁶

4 ounce size! after shave lotion. For your man.

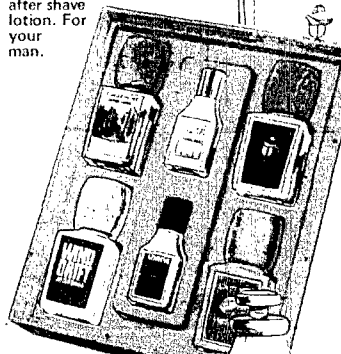

**ENGLISH
LEATHER
6 PC. SET**

5⁹⁶

AFTER SHAVE LOTION
English Leather 2 oz.
Timberline 2 oz.
Lime 2 oz.
Windrift 2 oz.
Ginseng .05 oz.
Musk .05 oz.

**OLD SPICE AFTER
SHAVE LOTION**

1⁴⁶

4 1/2 ounce size! By Shulton.



**BRUT 33
7 OUNCE
SPLASH
ON
LOTION**

1⁶⁶

7 ounce size! Perfect for Dad's day.



LIKE IT? CHARGE IT!

**BRITISH STERLING
AFTER SHAVE LOTION**

3⁹⁶

3.8 ounce size. For Father's Day!

YOUR SATISFACTION IS ALWAYS GUARANTEED

WE RESERVE THE RIGHT TO LIMIT QUANTITIES EXCEPT WHERE PROHIBITED BY LAW

PAGE 3

PLUG INTO SAVINGS AT PAMIDA!

HOOVER UPRIGHT WITH 5 PIECE TOOL SET, NOW

59⁹⁶

Deep cleaning action from finest quality Hoover. It beats as it cleans as it sweeps. Full time edge cleaning. 9 1/2 quart disposable bag. Complete with 5-piece tool set. Model U4165

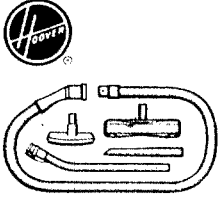

PAPER PLATE HOLDERS

4 \$1 FOR 1

5 lock tabs hold any size round paper plate firmly. Dishwasher safe.



ANCHOR 74 OZ. PITCHER

\$1

Perfect for iced tea! Spearmint or Spicy Brown colors. Model G4174 and Y4274.

Matching 16 ounce glasses...8 for \$1.00



TERRIFIC SAVINGS! NORTHERN TISSUES

66¢

Soft, absorbent 4-roll package. White or soft pastel colors.



ADJUSTABLE SINK BOARD

2⁹⁶

3/4" thick northern hardwood. Finished with wood preservative.

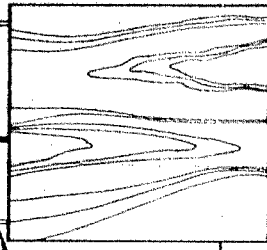

MR. COFFEE 10 CUP COFFEE MAKER

18⁹⁶

Mr. Coffee, recognized throughout America as the No. 1 selling coffee maker. Mr. Coffee brews coffee better, faster and easier than any coffee maker. Model CB-600.

MR. COFFEE

GENERAL ELECTRIC DIGITAL ALARM CLOCK AT SAVINGS

Lighted dial and snooze alarm. Large read out in digital design. Model 8142-412.

9⁹⁶



NORELCO GOTCHA GUN 1200 WATT COMPACT BLOW DRYER

Compact with a fold-up handle, so it's easy to store. And it's powerful with 1200 watts! It's extra-light, less than 1 pound—so Gotcha Gun is easy to handle. 3 speed and temperature settings. Model HB1777.

17⁸⁸

Norelco



DRY GUY BY CLAIROL

16⁹⁶

1000 watt adjustable styling dryer with dual voltage. 3 levels of heat and speed. 3 snap-in attachments. Lightweight. Model CH-1.

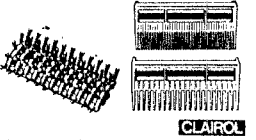

FATHERS DAY SUNDAY JUNE 18TH

GET A MASSAGE WITH EVERY SHOWER...by WATER PIK

13⁹⁶

The greatest thing to happen to showers since hot water. It delivers up to 9000 pulsating jets of water per minute to soothe and massage. Or adjust for regular flow. Model SM-2

Water Pik®

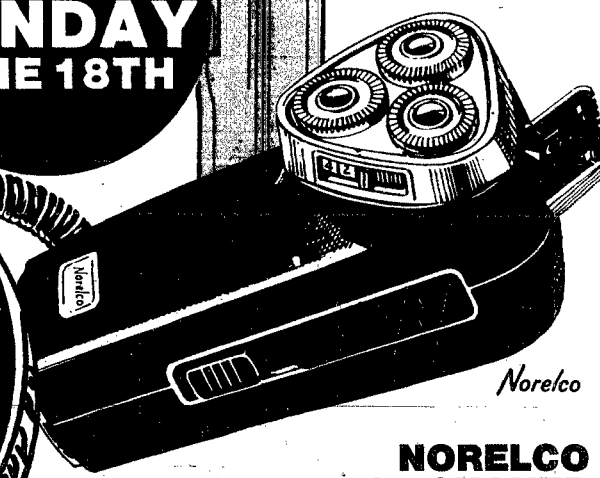
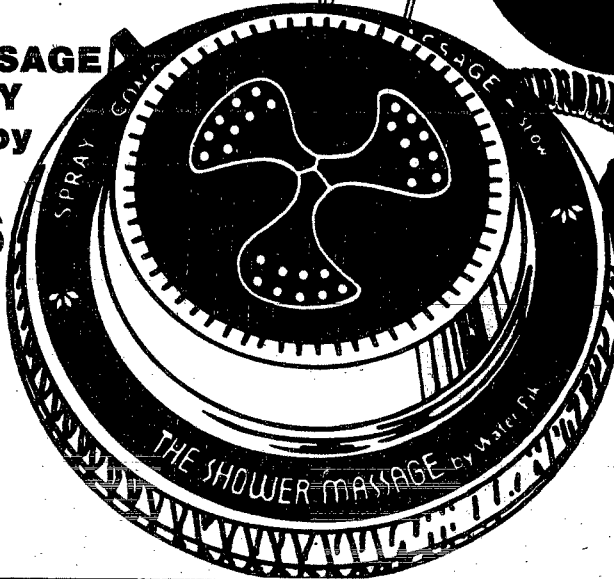

NORELCO TRIPLE HEAD SHAVER

29⁹⁶

It's the one electric that's earned the right to be called a razor. 36 self-sharpening surgical steel blades, twice as many as ever before. No nicks, no cuts, razor close, razor sharp and smooth. 9 closeness/comfort settings. It's the one razor that doesn't get 'cha. HP 1121.

YOUR SATISFACTION IS ALWAYS GUARANTEED

**GRAN PRIX AM/FM
DIGITAL CLOCK RADIO**

24⁸⁸

Superb, static-free FM music. Powerful AM standard broadcast. New, modern styling. 60 minute snooze timer. Lighted leaf digital clock movement. Wake to music or buzzer. Walnut grain and brushed chrome. Model DCR-1700

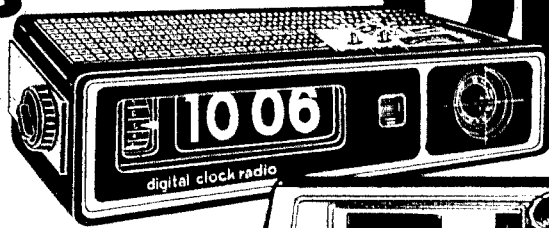

Our Gigantic Mid-Summer Discount DAYS!

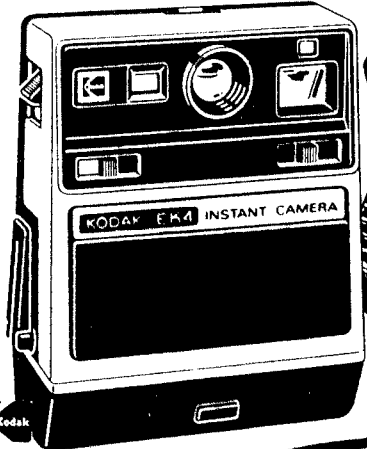

**KODAK EK4
INSTANT CAMERA**

36⁸⁸

Manually operated print ejection, many great features make this camera fun and easy to use. Take instant pictures with satinluxe finish that develop in minutes in front of your eyes. Just load and shoot!

**GREAT
FATHERS
DAY
GIFT
IDEAS**

**GRAN PRIX 4750 RECIEVER
WITH SP1600 SPEAKERS**

59⁸⁸

AM/FM stereo receiver with 8 track tape player. Stereo headphone jack, phono input jacks. 4-speaker output jacks. Buy today!



LIKE IT?
CHARGE IT!

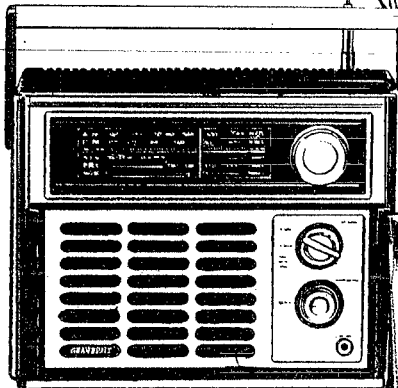

**GRAN PRIX 5 BAND
PORTABLE RADIO**

16⁸⁸

AM/FM Police/Aircraft/Weather radio. AC battery operation. Receives AM/FM broadcasts. Built-in AC power cord. Personal earphone included. 8 1/2" x 8 1/2" x 3 1/2". MODEL APW210

**HY-GAIN 40 CHANNEL
CB BASE STATION**

67⁷⁷

Featuring an exceptionally accurate phase-lock-loop frequency generator for all 40 channels. Solid state, 5 watt unit operates AC/DC with minimal power consumption. Built-in microphone. Top mounted noise limiter. Model 3087.



**MIDLAND
40 CHANNEL
CB RADIO**

39⁸⁸

Top view control panel. Easy sight from driver's seat. Automatic gain control, noise limiter and more! No. 77-830.

MIDLAND 19" COLOR TV

249⁸⁸

Reliable solid state chassis. Big 19 inch screen with 4 inch dynamic speaker. Attractive walnut color metal cabinet. Advanced integrated circuits. Positive detent tuning on UHF and VHF channels. No. 15-269.



**ECA 12 INCH
BLACK 'N WHITE
TELEVISION**

79⁸⁸

12" diagonal measure. Teakwood walnut cabinet. AC/DC operation indoor or outdoor! Earphone for private listening. Keyed automatic gain control. Can be used with a 12 volt battery pack for outdoor. 90 day warranty. 1 year parts and 2 years picture tube warranty. Model E-1800.

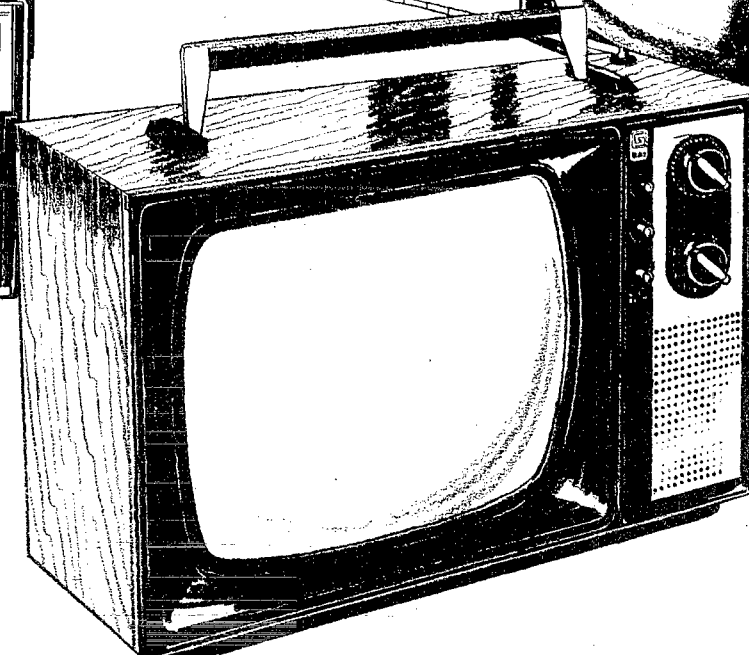

BRAND NAMES YOU KNOW AND TRUST

WE RESERVE THE RIGHT TO LIMIT QUANTITIES EXCEPT WHERE PROHIBITED BY LAW

PAGE 5

PLANO DELUXE 3-TRAY TACKLE BOX

6⁹⁶

3 stay-dry ribbed trays have 25 compartments for all sizes of baits, lures, etc. Model 6300N.

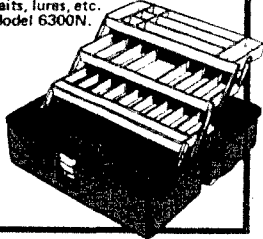

PLANO 4 DRAWER TACKLE BOX, NOW

19⁹⁶

4 drawers with 26 compartments. Deep bottom drawer for reel and other gear. 737.

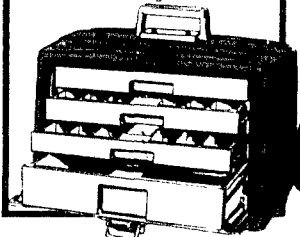

STEARNS HUNTING AND FISHING VEST

18⁸⁸

Good size pockets with Velcro closures. Velcro zipper and accessory rings. 55V165.



DELUXE FISH 'N FILLET KNIFE

9⁹⁶

Designed by Normark specifically for filleting fish. Comes with handy carrying pouch. Model DP306.



DAD WILL LOVE THIS! 3-IN-1 FISHING CHAIR

9⁸⁸

This unique chair may be assembled in 1 of 3 ways. As a camp stool, picnic chair or fishing chair. All components are included.

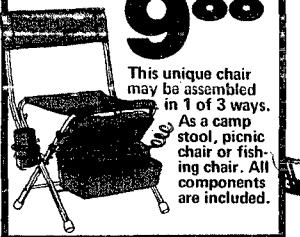

MAGIC WORM FARM

3⁶⁶

Contains a bag of magic worm bedding and magic worm food. Instructions also included.

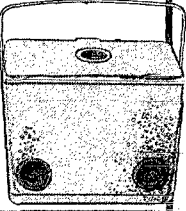

SAVINGS ON DAIWA MSI-59 MINISPIN ROD & REEL TRAVEL PACK

34⁸⁸

Top quality tough plastic construction with snap lid compartments inside for lures, bait, etc. Plus, top quality rod and reel set.



LIKE IT? CHARGE IT!

DAIWA 1300C/1512 SKIRTED SPOOL SPIN FISHING COMBINATION

22⁸⁸

For medium freshwater ultra-light saltwater fishing. Now with new anti-reverse design, new anodized aluminum handle.



Just in time for Father!

PICK DAD'S FAVORITE! YOUR CHOICE...

• ZEBCO 3113 SPINCAST COMBO **19⁹⁶**



• DAIWA 208RL/5031 COMBO **19⁹⁶**

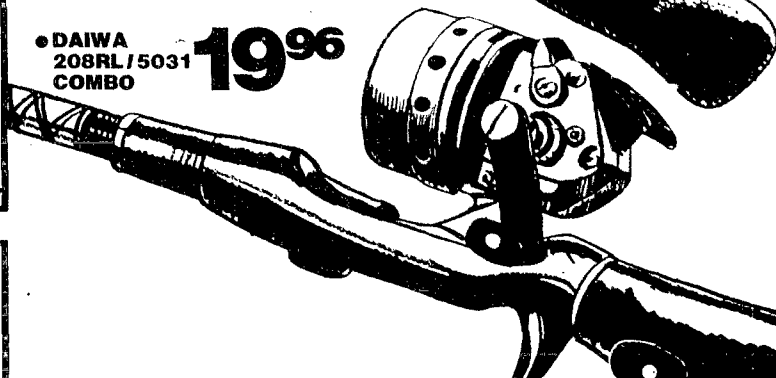

• DAIWA MCI-59 TRAVEL PACK **19⁹⁶**

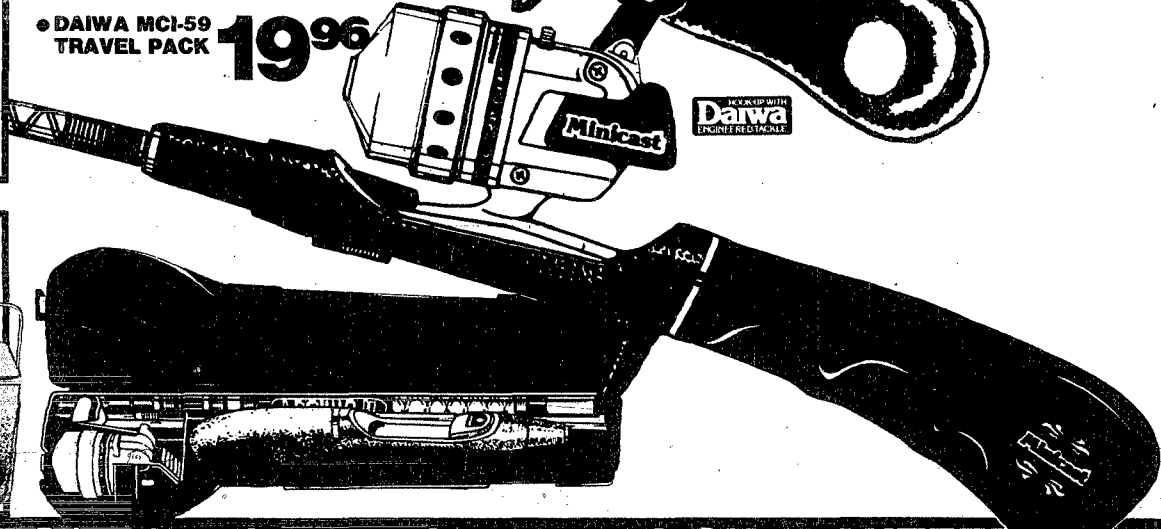

1996
EACH

- ZEBCO 3113 UL Spincast Combo, ultra-light for the ultimate in fishing fun. Omega 113 reel comes ready-to-fish with pre-spoiled Dupont Stren monofilament.
- DAIWA 208RL/5031 Spincast Combination designed to be the best for all-purpose freshwater fishing.
- DAIWA MCI-59 Minicast Rod & Reel Travel Pack. Five-piece rod. Pack case holds reel, pack, rod, lures and flies.

YOUR SATISFACTION IS ALWAYS GUARANTEED

Our Gigantic Mid-Summer Discount DAYS!



**COLT POLICE
POSITIVE
38 SPECIAL
4" BARREL
REVOLVER**

\$133

A small frame revolver, easy to draw. Has become the official hand gun of many large and small police departments. Model D2442.

NELSON ASSORTED GOLF PUTTERS

2⁹⁶

Five popular styles...swing weight, off set, dual face, pendulum and watch play. Tempered steel shafts.

6 TOP BRAND PRO GOLF BALLS

11⁸⁸
DOZEN

- Titleist
- Spaulding-Top Flight
- Wilson-Pro Staff
- Dunlap-Blue Max Top Staff or Pro Flight-XXX Outs.....5.88doz.

MAC GREGOR GOLF BAG

15⁸⁸

Colorful, long wearing vinyl. 3-stay construction. 1-piece molded club divider. Ultra-wide padded sling strap. 4 color combinations.

AJAY GOLF CART, NOW

15⁸⁸

Automatic folding, stands and rolls when folded. Push button handle. Four color to choose from. Model 10705

WILSON TENNIS RACKET, NOW

9⁹⁶

Wilson Baseline wooden tennis racket...great for a beginner. Easy grip handle.

WILSON X-DUTY YELLOW TENNIS BALLS

1⁹⁶

Provide longer play on hard court surfaces.

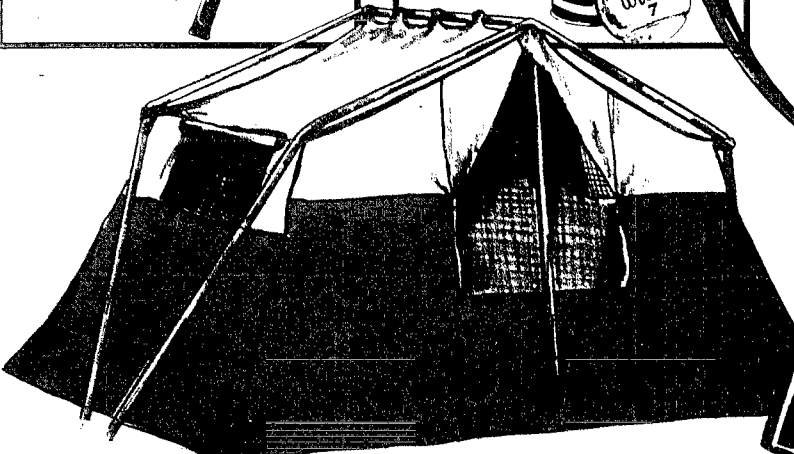

WENZEL 8'x10' CABIN TENT

74⁹⁷

Weights 26 pounds. Fire-fighter Finish. Made entirely of 4 3/4 oz. polyester and cotton. Ventilation through large screened windows in side walls and California insect-proof zip door. Model 21102.



LIKE IT? CHARGE IT!



WENZEL 4 LB. SLEEPING BAG

14⁹⁶

33"x 77" size. Four pound polyester fill. Finest quality from Wenzel. Model 41089.

BEAR ARCHERY WHITETAIL HUNTER COMPOUND BOW

69⁸⁸

Features double tapered thermal bonded epoxy resin limbs. Positive weight control system. New power-tapered limb design. 6-wheeler design.

FIREARMS NOTICE
We sell guns for the sportman in strict compliance with all Federal, State and Local regulations.

GLENFIELD 22LR SEMI AUTO RIFLE WITH SCOPE AT SAVINGS

39⁸⁸

22 caliber, 18 shot magazine. One-piece walnut finished hardwood stock. Finest quality, low priced! Model 60

REMINGTON THUNDERBOLT 22 LR AMMUNITION

83¢

Delivers high velocity performance and accuracy. 50 count per carton. 10 Cartons/\$8.33

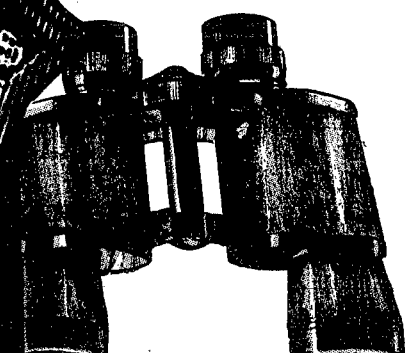

NELSON 7x35 BINOCULARS

18⁹⁶

7 power coated optics for sports viewing. Fast center focusing. Complete with carrying case.

BUY NOW FOR DAD'S DAY — SUNDAY JUNE 18th

WE RESERVE THE RIGHT TO LIMIT QUANTITIES EXCEPT WHERE PROHIBITED BY LAW

PAGE 7

Just in time for Father!

**KELLEY
WHEEL
BARROW**

13⁹⁶

Tough but lightweight wheel barrow with hefty 3 cubic ft. capacity. 1" tubular steel handles. Under braced for rigidity. From Kelley. KS.3.

**NEOSHO
4435-X
BUDDY-L
SMOKER
WAGON**

19⁹⁶

Flip top hood with 2 vent controls and modern recessed "full view" heat treated glass window. Fire pan is adjustable to 5 positions. 2 chrome plated cooking grids. Large 14 1/2 x 7 1/8" bottom shelf.



ALL YOU NEED TO KEEP YOUR LAWN PRIM & PROPER AT HUGE SAVINGS!

**EVERRAIN
OSCILLATING
SPRINKLER**

2⁹⁶

4 different water patterns. Top value!

**BLACK & DECKER
HEDGE
TRIMMER**

17⁹⁶

3000 cutting strokes per minute. 3-position safety switch. Detachable cord.

**BLACK & DECKER
CORDLESS
GRASS SHEARS**

14⁹⁶

3" wide blade. Model 8280.

**16" x 16"
REDWOOD TABLE**

2⁹⁶

16" x 16" slated California redwood. Lock seam legs with tops of genuine chrome-alite tubular steel non-mar tips. Quaker Industries.

10 POUND CHARCOAL

96¢

Faster starting and longer burning. Made with hardwood for that great flavor.



LIKE IT? CHARGE IT!

**1/3 H.P. AUTOMATIC
FEED WEED
TRIMMER, NOW**

18⁸⁶

Just tap unit on ground to release more line. Line guard allows right or left hand cut. Automatic line cutter. From K and S.

**WEB CHAISE
LOUNGER OR
16 POSITION LAWN
LOUNGER BOTH AT
1 PRICE!**

9⁹⁶

EACH

16 position click lounger. Tough steel construction. Heavy duty webbing for long wear. Adjusts to any position. quick and easy. 72" x 22" size.

Or relax in total comfort this summer in a web lounger. Top quality from Sun Terrace. Orange, Yellow, Green, or White. 6x 16" web.



**FABULOUS
GIFT
SELECTIONS
FOR DAD AT BIG
DISCOUNT
PRICES**

EVERY DEPARTMENT IS LOADED WITH SAVINGS

THE COMPLETE TUNE AND TEST KIT AT A SPECTACULAR PRICE!

19⁹⁶

Save money, save gas and time. So simple anyone can do it. Complete easy instructions. All that you need to complete the kit.



COOL CUSHION
5⁸⁸

Comfort rider, cool comfort in your car. Keeps air moving freely!

PORTABLE ELECTRIC AIR COMPRESSOR

14⁸⁸

Compact size, concentrated power. Delivers up to 65 lbs. of pressure.

IN DASH AM/FM CASSETTE RADIO, ON SALE

\$78

FM stereo indicator lights. On-off stereo on light. AM/FM slide control. Many other features you'll have to see to believe. Model KID-585.

DUPONT RAINDANCE CAR WAX, LIQUID OR PASTE

OUR SALE PRICE..... **2⁹⁶**
YOUR COST AFTER \$1 REBATE..... **1⁹⁶**

Raindance guaranteed to last longer. Keeps on beading and shining rain after rain, wash after wash. 14 oz. paste or 16 oz. liquid.



KRACO AUTO VACUUM

12⁸⁸

Powerful, hi-speed wide-mouth attachment. 16 foot cord for cars, boats, campers, trailers and mobile homes. Plugs into cigarette lighter. Brush and tool attachment.



KRACO TRI MAG 5 1/4" SPEAKERS

\$39

Low frequency response. 6" x 9" Speakers

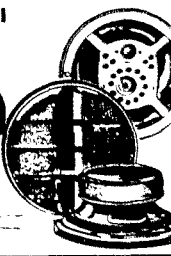

SUPER SPORT GRIP STEERING WHEEL COVER

2⁹⁶

Quick and easy installation. Extra thick cushion. Black or Tan

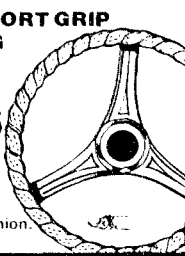

SAVE ON OUR PREMIUM STARFIRE POLY IV TIRES

Polyester cord helps a tire run smooth and virtually vibration-free. Run without irritating flat spot thump. 4-ply construction resists tire-killing blows. And traction blades are scientifically spaced around the tire to knife through water on wet roads. Our newest premium poly tire, now super sale priced!

*Panda's designation. No industry wide standards exist.

SIZE	PRICE	F.E.T.
B78-13	\$19.00	\$1.77
F78-14	\$24.00	\$2.26
G78-14	\$25.00	\$2.42
H78-14	\$26.00	\$2.60
G78-15	\$25.00	\$2.45
H78-15	\$26.00	\$2.65
WHITETALLS \$3.00 MORE PER TIRE PLUS F.E.T.		

\$19

B78-13 Plus \$1.77 F.E.T. Tubeless Blackwall

ALL PRICES PLUS F.E.T.



LIKE IT? CHARGE IT!

FABULOUS SAVINGS! JACK STANDS

2 \$5 FOR

Heavy duty tubing, fade-proof finish. 3,000 lb. capacity.

QUALITY WOODEN AUTO CREEPER SALE PRICED!

5⁸⁸

Hardwood with 4 cross bars. Professional quality. Padded headrest. Big 2 1/4" nylon wheels.

2 1/2 GALLON GAS CAN, LOW PRICED

3⁸⁸

Squat type deluxe vented can. 8 1/2" reversible spout, complete with cap.

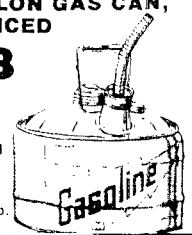

"ALL AMERICAN" DC POWER TIMING LIGHT

14⁹⁶

Top professional quality. Xenon tube provides a brilliant blue-white flash of light. Low priced!

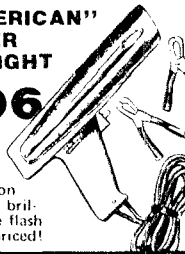

SPLASH GUARDS

1⁴⁶

Stainless/vinyl. White or black. Small size, 418 or 419.

LARGE SIZE **3.46** 423 or 424.

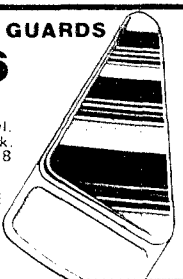

DELUXE CAR COMPASS

5⁸⁸

Finest quality from Arguide. Great gift idea for Dad!

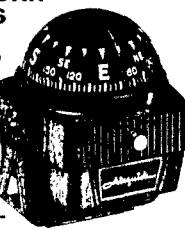

BUY NOW AND SAVE ON HEAVY DUTY AUTO CAR RAMPS

15⁸⁸ PAIR

Has safety guards, red baked enamel finish. For all cars.

HYDRAULIC JACK PRICED FOR ACTION

59⁸⁸

Smooth, easy operation and dependability. Heavy duty, where lifting and pushing are needed. 1 1/2 ton capacity.

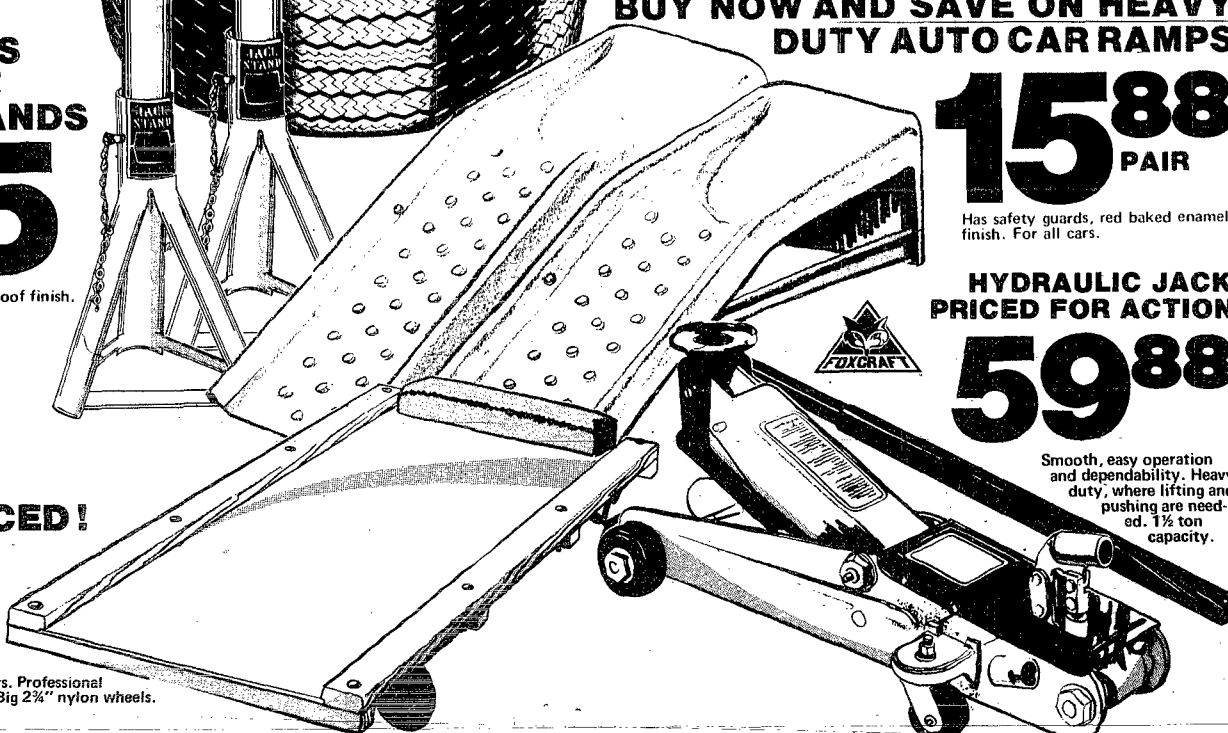

TOP SELECTION ON AUTOMOTIVE PRODUCTS

SAVE ON SAW
HORSE BRACKETS

96¢
PAIR

Features flanged
nail holes for
quick, easy as-
sembly.



**12 INCH
REMINGTON
CHAIN SAW**

69⁸⁸

Top quality, fully automatic chain oiling. Lightweight,
easy to operate and handle. Spark arresting muffler.
Super gift idea for Dad. Model 69409 Yardmaster.

Just in time for Father's Day

**EVEREADY BATTERIES
STOCK UP NOW & SAVE!**

6 BATTERIES

96¢

Proven performers. "C" and "D"
cell flashlight batteries. Sold 2
in a package.



**BLACK &
DECKER
2 SPEED JIG
SAW**

12⁹⁶

1/3 H.P., two speeds.
Double insulated, includes
wood cutting blade.
Model 7530.

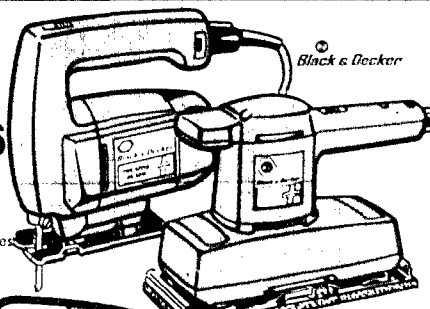

**BLACK &
DECKER 3/8" DRILL**

11⁴⁴

A good choice for general purpose work.
Double insulated-needs no grounding.
Double reduction gear system. Model
7104.

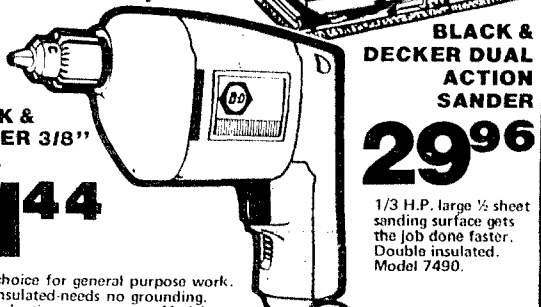

**BLACK &
DECKER DUAL
ACTION
SANDER**

29⁹⁶

1/3 H.P. large 1/2 sheet
sanding surface gets
the job done faster.
Double insulated.
Model 7490.

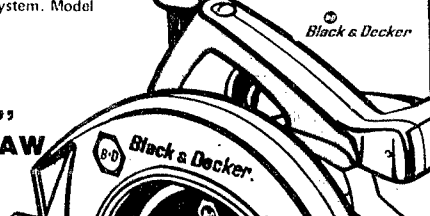

**BLACK &
DECKER 7 1/4" CIRCULAR SAW
LOW, LOW
PRICED!**

19⁹⁶

1 1/3 H.P. Power-lock
off button guards a-
gainst accidental starts.
Sawdust ejection.
Double insulated.
Model 7308.

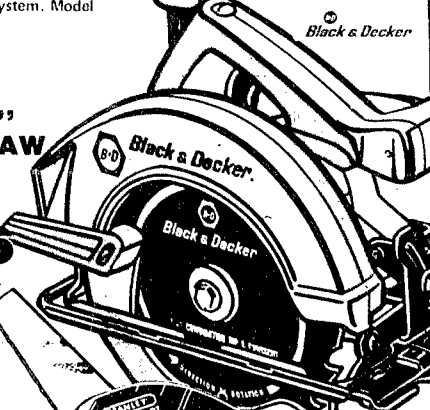

**STANLEY
TOOL SALE**

5⁹⁶
EACH

● 16 OZ. HAMMER:
Steel handle with
baked enamel finish.
Model H1 1/2.

● 26" HAND SAW:
Tempered steel
blade with set and
bevel-filed teeth.
Model 1526.

● 16' TAPE MEASURE:
3/4" wide, easy to read
blade. Power return.
Model PL316.

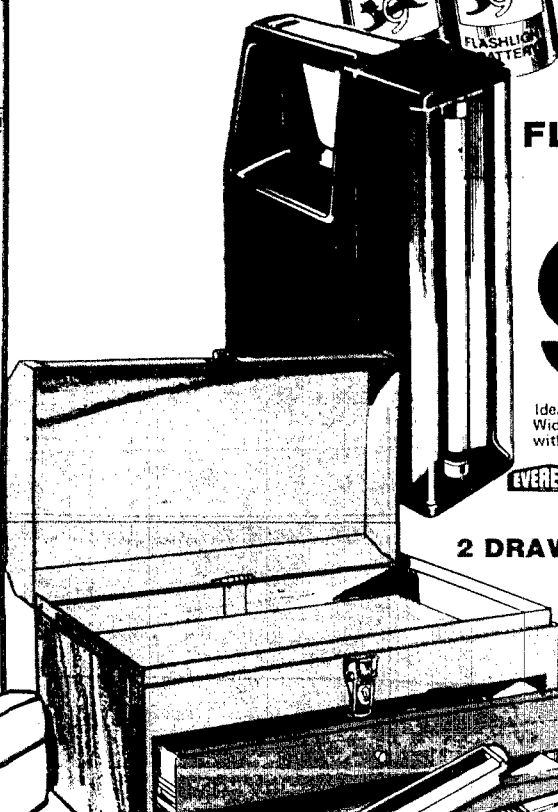

**2 DRAWER TOOL CHEST
SALE PRICED**

16⁸⁸

An ideal size. Keeps all your tools
handy and neat. Model AA240.

**SHOP VAC
FOR RUGGED,
WET AND DRY
CLEANING POWER**

29⁹⁶

Power cleans...wet or dry. It has high suction power for
liquids or dry debris. Easily converts to a blower for
special jobs. UL listed. 5 gallon capacity. Amazingly
light weight. Model 600-07-2.



YOUR SATISFACTION IS ALWAYS GUARANTEED

**11 PC. WRENCH SET
PRICED FOR ACTION**

7⁹⁶

Combination box and open end. Top quality from Power Master. Drop forged alloy steel. Triple chrome plated. No. 5730. SAE only.

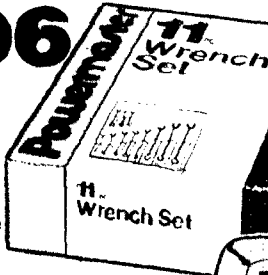

**24 DRAWER
UTILITY
CABINET**

5⁹⁶

Transparent drawers. Rugged construction, built-in handle for easy movability. For use in home, office, or workshop. Model 624.

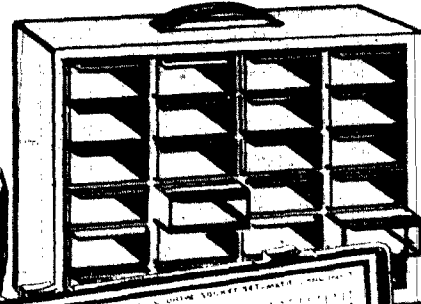

**SWINGLINE
ELECTRIC
STAPLE GUN**

16⁹⁶

Fast, easy squeeze trigger operation. Lightweight on/off trigger lock. Easy load. Built-in staple remover. Drives 5 staple sizes plus Loktite Staples. Steel base construction. Model 34201.

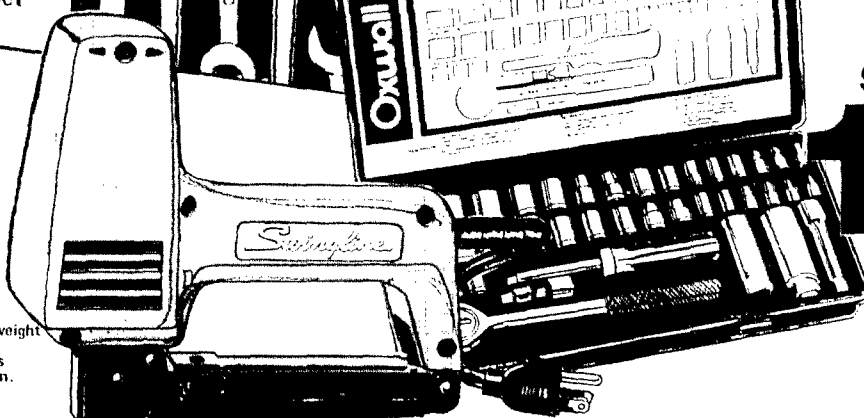

**OXWALL
42 PIECE
SOCKET SET**

12⁹⁶

42 pc. combination 1/4" 3/8" drive socket set Metric and inch. What a complete set Dad will Love! Superior quality and workmanship. Model 1541.

**WIRE BRUSH
WITH SCRAPER**

1²⁶

For scraping loose particles, blisters and scales, for removing rust.



**1 1/2 INCH WOOD
SCRAPER**

1²⁶

Double sided blades of high carbon steel. Re-sharpen with file.

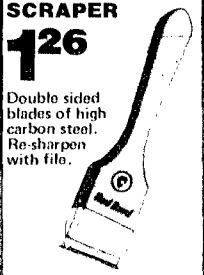

**ELECTRIC GLUE
GUN**

4⁹⁶

Trigger controlled for home repair, construction and caulking. Permanently bonds in 60 seconds.

Bostik



**FLEA & TICK
SHAMPOO**

96[¢]

For dogs or cats. Solves all kinds of problems 12 oz.



**12 OZ.
FLEA
SPRAY**

1²⁶

The Protector kills fleas and ticks. Also lice. 12 oz.



**FLEA COLLAR
FOR DOGS, CATS**

1⁶⁶

Kills fleas, and ticks when a problem.



**LARGE 9'x12'
DROP CLOTH**

4 FOR 96[¢]

1 piece heavy plastic. Has hundred's of uses.

**PAMIDA
PREMIUM
QUALITY
WALLPAINT**

**3⁹⁶
GALLON**

Dries quickly, soapy water clean up. For use on interior walls, ceilings, plaster, wallboard, brick, cinder block and primed metal. White only.

**PAMIDA LATEX HOUSE
PAINT AT A FABULOUS
SALE PRICE! BUY NOW!**

**5⁹⁶
GALLON**

For use on wood siding, masonry, stucco, primed metal and asbestos. Quick drying produces a long-lasting, low luster finish. Soap and water clean-up. White only.

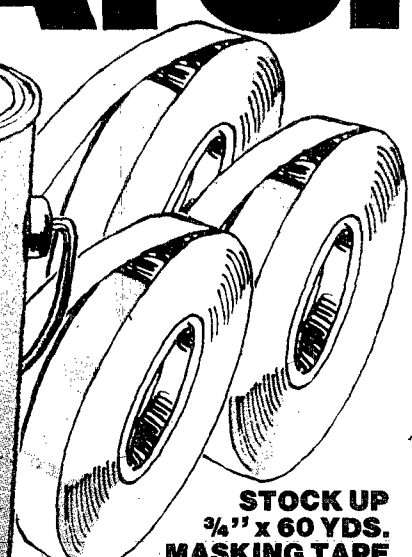
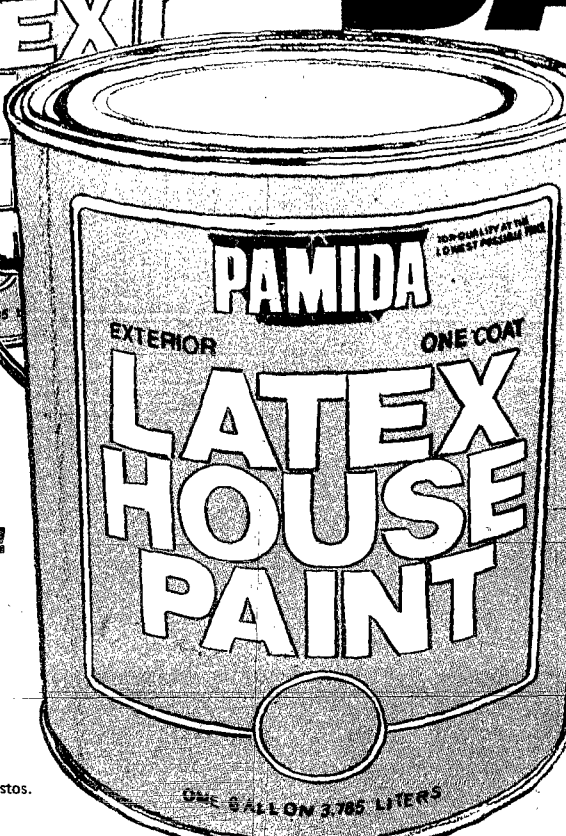

**STOCK UP
3/4" x 60 YDS.
MASKING TAPE**

3 ROLLS

96[¢]

YOUR SATISFACTION IS ALWAYS GUARANTEED

WE RESERVE THE RIGHT TO LIMIT QUANTITIES EXCEPT WHERE PROHIBITED BY LAW

PAGE 11

**ASSORTED 6 INCH
POT SIZE PLANTS**

3⁹⁶

- Double Marginatas
- Yucca Buds
- Alexandra Palm
- Norfolk Island Pine
- Philodendron Selloum
- Schefflera

**ASSORTED 8 INCH
POT SIZE PLANTS**

6⁹⁶

- Dracaena Marginata
- Philodendron Selloum
- Schefflera
- Croton
- Ficus Decor
- Ficus Benjaminia
- Ponytail Palm

**4 POUND
POTTING
SOIL, NOW**

**3 \$1
BAGS**

Prepared for all plants. Healthy mixture. Buy now!



Our Gigantic Mid-Summer Discount DAYS!

**2 SPEED
20 INCH
THINLINE
BOX FAN**

16⁸⁸

Compact in design. Moves air with new jet stream blade design. Lightweight size. No. 204001.

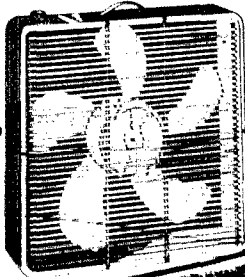

HAMMOCK WITH PILLOW

100% polyester duck with fringed edge. Mildew resistant, won't fade. Steel frame. Complete with pillow. No. 8401.

15⁸⁸

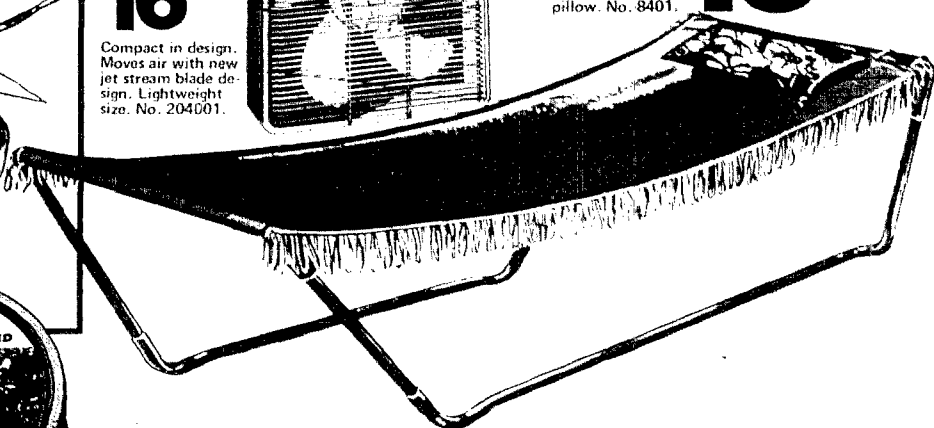

**50 FT. NYLON
GARDEN HOSE**

3⁷⁶

Superflex nylon reinforced. Low temperature flexibility. Unconditionally guaranteed. 50 ft. by 1/2 inch. Model 7500.



VINYL GARDEN HOSE

1⁹⁶

100% vinyl with solid brass couplings. Fully warranted. 1/2 inch inside diameter. Model 7565.

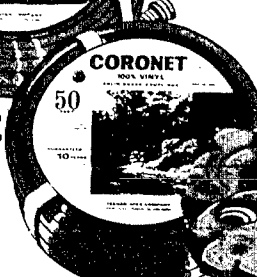

**MR. TURTLE SLIDE 'N SPLASH
SWIMMING POOL BY COLECO**

Heavy duty polyethylene in brilliant green and decals. Molded side seats and slide. Model 701

8⁸⁸



**30" DELUXE
BAT AND
BALL SET**

96¢

Provides hours of fun for the kids. 7237



9 1/2" PLAYBALL

66¢

Brightly decorated playballs in assorted colors. 9813-41.

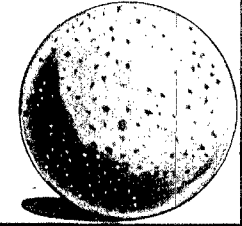

**QUALITY TURCO BIG TOP GYM SET
AT ONE SPECTACULAR LOW PRICE!**

A popular decor on a popular gym makes Big Top a real winner. Play features include a trapeze bar, two cord plastic swings, a two passenger glide ride and a five foot galvanized slide. Model 6142.

- HEADBAR—8'6"
- LEGS—6'9"
- SLIDE PLUS PLATFORM—5'
- BASE AREA—11' x 8'3"
- OVERALL HEIGHT—7'5"
- WEIGHT—72 pounds

39⁸⁸



LIKE IT? CHARGE IT!

YOUR SATISFACTION IS ALWAYS GUARANTEED

SAVE TIME AND & MONEY DURING OUR SUPER SALE OF CANNERS & COOKERS

7 JAR CANNER SALE PRICED 5⁸⁸

Easy-clean Porcelainware. 7 jar home canner and preserver made of easy clean Porcelainware. 21 quart. Complete with rack. Model B22.



LIKE IT? CHARGE IT!



MIRROMATIC 12 QUART PRESSURE COOKER

25⁸⁸

Cut cooking by 2/3rds. Tenderizing economy cuts of meat, capturing flavor and color of vegetables and saving healthful nutrients. Pressure cooking is the only method recommended by USDA for safe canning of low acid or nonacid foods such as meat, poultry, seafood and all common vegetables. Model M 0312.

A Rain Check will be issued upon request on an advertised item not available due to an unforeseen reason at the time of purchase and Gibson's will notify you when the item is received or will sell you a comparable item at a comparable discount. Satisfaction guaranteed always.

88¢ SALE

- **JAR LIFTER**
Just what every home canner needs. Model 1269.
- **CANDY & JELLY THERMOMETER**
Records accurately and dependably. Sealed glass tube. Non-toxic blue fluid against pink scale for easy reading. 267.
- **MIRRO MEASURING CUPS**
4 piece set. Model 2300-15.
- **FREEZER BAGS QT. SIZE**
Extra-strong plastic for best flavor protection. Also excellent for left-over food storage. 80 Pack.
- **PLASTIC CONTAINERS**
3-quart size, 4-1½ pint size or 5 pint size plastic freezer containers with colored lids.

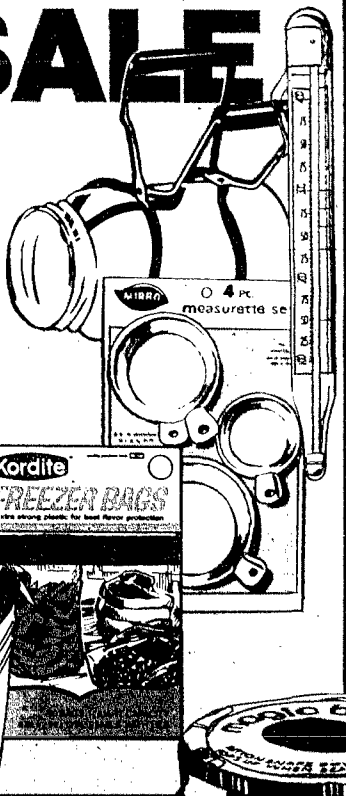

2 FOR 88¢ SALE

Buy two or buy them all... necessities for the home canner now on sale!

- **CORN STRIPPER**
Pure stainless steel blades. Spring action handle. Model 298.
- **JAR WRENCH**
Triple plated chromed steel. Easily removes any size jar or bottle lid. Model 306.
- **1 PINT DIPPER**
Model 1270.
- **ECKO UTILITY TONGS**
Natural angle helps keep hands away from heat and splatter. Model 56K.
- **CANNING FUNNEL**
Model 269.
- **SALT & PEPPER SET**
Clear plastic authentic Mason jar. Model 523.

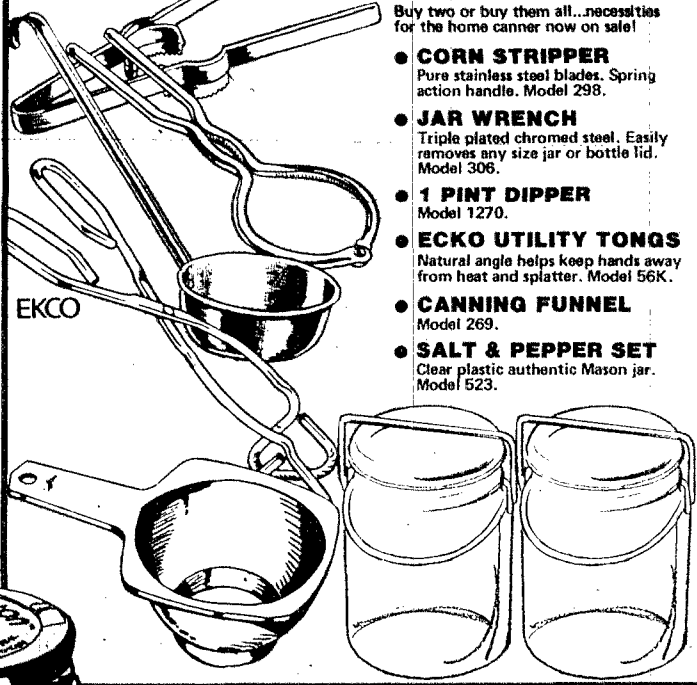

LOW, LOW PRICE ON MAGIC MASON JARS

1⁹⁶
A DOZEN

Quart size Mason jars made of high quality glass. Complete with metal rings and special Magic Button Mason lids. 12 count box. Start canning with confidence!

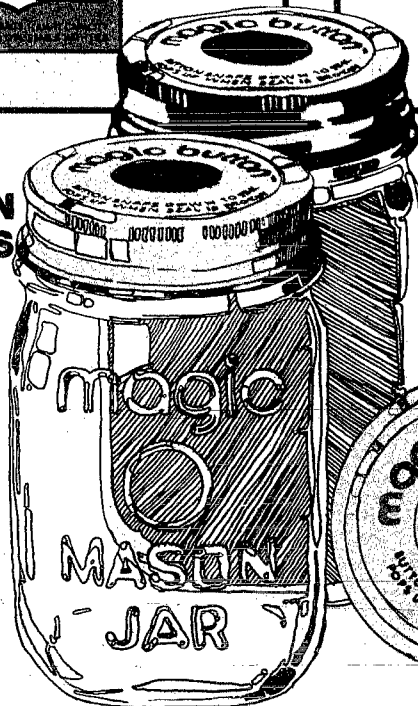

MAGIC BUTTON MASON JAR LIDS AT SAVINGS

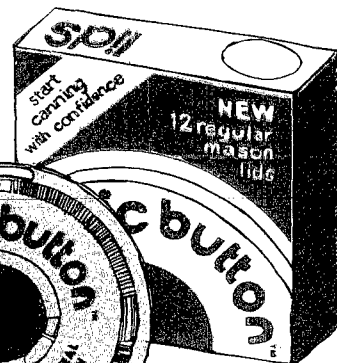

4 BOXES \$1

Magic Button Mason lids - the ones with the red button that actually pulls down and makes a loud click as the seal takes. And the button pops up to let you know if the seal is broken. 12 count box.

YOUR SATISFACTION IS ALWAYS GUARANTEED

WE RESERVE THE RIGHT TO LIMIT QUANTITIES EXCEPT WHERE PROHIBITED BY LAW

**UNBELIEVABLE LOW PRICE
ON WOMENS SWIMWEAR**

\$9

One piece or two piece styles in colorful prints, solids or bold stripes. Spaghetti straps, cross-over straps, strapless, halters. They're all here in this large group. 2 pc. in boy leg styles and bandeau bras. Sizes 8-16, 7/8-15/16 and 32-38.

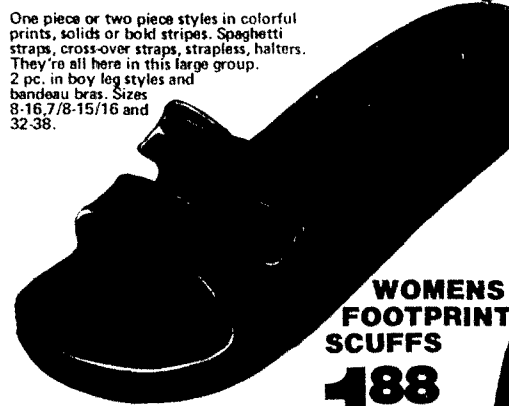

**WOMENS
FOOTPRINT
SCUFFS
188**

Waterproof scuffs with a foot print molded in to the insole. Easy care footwear for the pool and beach. Sizes S-XL.



**WOMENS
STRIPED
THONGS ON
SALE!**

3.99

Colorful thong sandals with a contemporary fashion flair. Striped cushion crepe wedgies topped with coordinating braided thong upper. Sizes S to XL.

**COOL, SUMMER
TANK TOPS AND
HALTERS PRICED
FOR ACTION**

\$2

A style to fit your every whim. Dare to be bare this summer. Show off your tan. Sizes S-M-L and one size fits all. Assorted solids and prints.

**SPECTACULAR
GROUP OF
WOMENS DENIM
SHORTS**

\$5

Large group of basic or novelty denims. Many styles and pocket treatments. Now sale priced at Pamida. Sizes 5-15 and 8-16.

**KEEP COOL THIS
SUMMER IN
WOMENS
DUSTERS AND
LOUNGERS**

444

100% cotton, nylon or loop knit fabric in assorted summer prints or solids. Sizes Small to Extra Large.

**WOMENS POMPOM
SPORT SOCKS**

76¢

Orlon and nylon blend. White sock with colored pompoms. Sizes 9-11.



GYM SHORT SALE

\$2

Polyester and cotton blend. Solid color with stripe trim. In Womens sizes S-M-L.

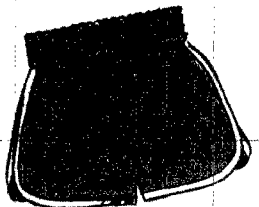

LIKE IT?
CHARGE IT!



**DARE
TO BE
BARE!
WOMENS
SUNDRESSES
SALE PRICED!**

12.88

Poly and cotton, gauzes, poly interlock fabrics to choose from. Bright summer solids or splashy prints. A style to flatter your figure. Sizes 5/15 to 6/18.

A Rain Check will be issued upon request on an advertised item not available due to an unforeseen reason at the time of purchase and Gibson's will notify you when the item is received or will sell you a comparable item at a comparable discount. . . satisfaction guaranteed always.

YOUR SATISFACTION IS ALWAYS GUARANTEED

Childrens Playwear SALE



Little and big girls tops and little and big boys tops, tanks, screen print T-shirts and others. See girls 4 to 14 gym shorts in this big group. Now all at one spectacular sale price.

1.26

EACH

This is an unbelievable sale. You'll want to buy several and save! Girls 4 to 14. Boys 4 to 18.



TERRIFIC BUY!
LITTLE & BIG BOYS DENIM SHORTS

2\$5 PAIR

100% fine cotton denim. Sanforized no-iron. Five belt loops. Yoke back. Two styles. Self-hemmed and cuffed. Sizes 4 to 18.

LITTLE & BIG BOYS BASKETBALL SHORTS

1.66

Polyester and cotton blend in bright colors, contrast piping, elastic waist. Sizes 4 to 18.

BOYS 4 to 7 POLYESTER PAJAMAS

2.47

Short legs and short sleeves. 100% polyester, flame retardant does not contain Tris. Assorted prints.

GIRLS 4 to 14 SLEEPWEAR

3.44

Cute T-shirt styles or regular baby doll styles in assorted colors.

ROASTED & SALTED SUNFLOWER SEEDS, NOW

2.88¢ BAGS

Roasted to nutty perfection. Salted inside and out. You'll love 'em! 10 ounce bag.

AQUA NET HAIR SPRAY

56¢

10 ounce size. Regular, Super or Unscented.

OLD SPICE STICK DEODORANT

86¢

2 1/2 ounce in Regular or Lime scent.

ECONOMY PACK FRESHEN-UP GUM

68¢

● PEPPERMINT
 ● CINNAMON
 ● SPEARMINT
 10 Pack.

GILLETTE ALL-STAR SPECIAL REFUNDS!

In-the-mall cash refunds with proof of purchase and certificate from our Gillette All-Star display.

\$2 refund on Atra® razor
50¢ refund on Atra® 5's
75¢ refund on Trac II® 9's

BARBASOL SHAVE CREAM

2 \$1 FOR 1

11 ounce in Regular or Menthol.

● SHOWER TO SHOWER
 ● REVLON TREATMENT SHAMPOO
 ● REVLON INSTANT HAIR CONDITIONER

96¢ EA

8 ounce Shower to Shower
 6 ounce Shampoo
 5.5 ounce Conditioner

MMM-GOOD PLANTERS RIPPLE POTATO CHIPS

96¢ TRIPLE PACK

GILLETTE ALL-STAR SPECIALS!

Atra only **2.96**
Atra only **96¢**
GILLETTE TRAC II only **1.99**

Vote for your favorite players
 All-Star Ballots At our Gillette All-Star display.

CREST TOOTH PASTE

86¢

7 ounce size. Regular or Mint.

YOUR SATISFACTION IS ALWAYS GUARANTEED

WE RESERVE THE RIGHT TO LIMIT QUANTITIES EXCEPT WHERE PROHIBITED BY LAW

PAGE 15

**QUALITY GRACO
PORT-A-CRIB**

\$25

Famous Port-A-Crib name. Mattress included. Hardwood construction. Casters for easy moving. Plastic twisting rails, adjustable legs, dropside. 27" x 42" size.



**RAMIDA and GIBSON'S
DISCOUNT CENTER**

**THIS SALE LASTS 5 BIG DAYS
DON'T MISS IT! SHOP TODAY!**

**Our
Big 5 Day Mid-Summer
Discount
Baby SALE**

**CENTURY BABY
CARRIER**

\$3

Light, durable sanitary liner. Purulite polyethylene. Color. Colorful easy to clean vinyl covered cushion. 2 piece adjustable stand.



**KEEP BABY BUSY
IN ROUND ABOUT
WALKER**

\$8

Large molded play 'n' eat tray. Large base ring with 5 sets of dual wheels for extra stability. Adjustable seat, folds flat for storage.

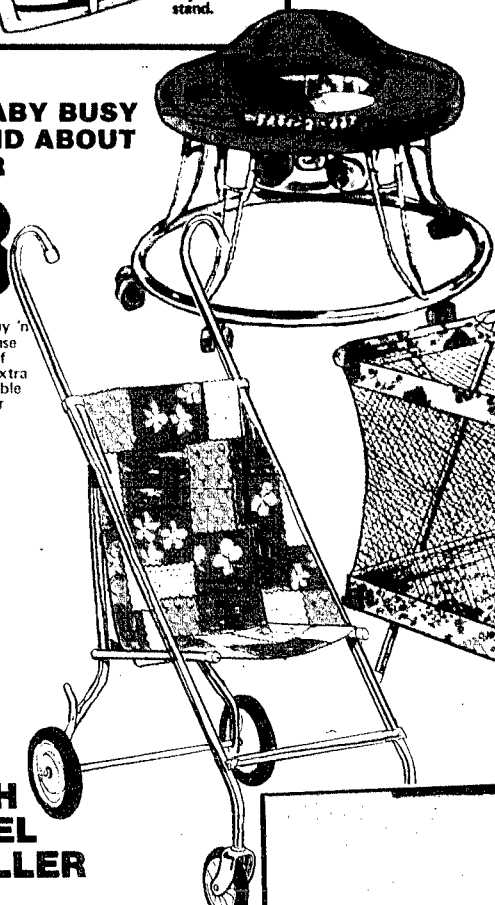

**DYN-O-MITE™ BABY CARRIER/
CAR SEAT**

\$15

Lightweight baby carrier, or toddlers play chair. Crash tested. Easily installs in car with adult lap belts. Molded, durable plastic. 5-position adjustment.

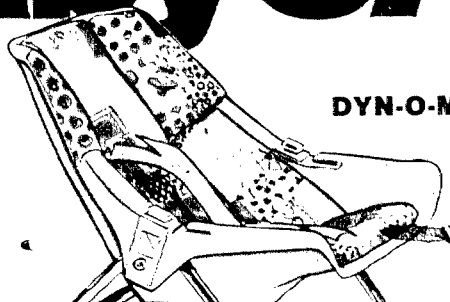

**WELSH
PLAY YARD**

\$19

A playpen for safety's sake. Padded rail. Strong, yet easy to fold-up construction. Cute, bright print. Nylon mesh. 38" x 38" size.

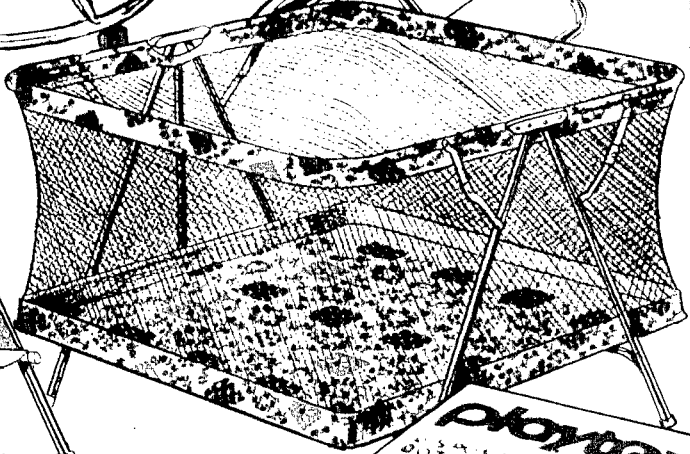

**REPLACEABLE
PLAY PEN PAD**

\$4

Water-proof cover. 38x38" size.

**WELSH
TRAVEL
STROLLER**

\$15

Lightweight, easy to maneuver. Compact, collapsible safety lock and strap. Country patch blue. Easy to take baby anywhere!

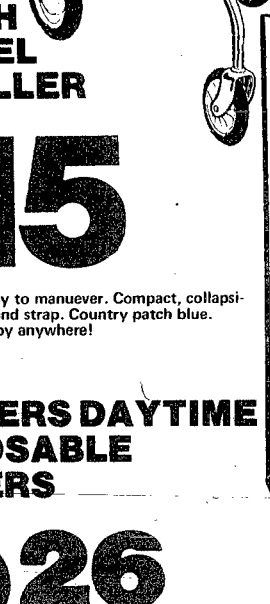

**DAYTIME
Pampers**

**PAMPERS DAYTIME
DISPOSABLE
DIAPERS**

226

30 count disposable daytime Pampers with custom fit tapes. Keep baby drier. Sale priced!

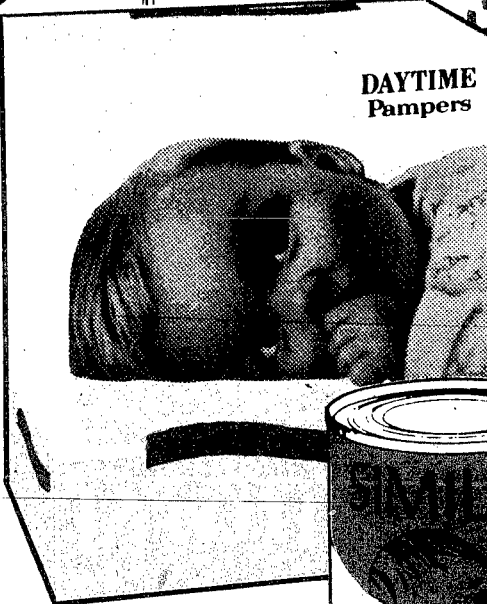

A Rain Check will be issued upon request on an advertised item not available due to an unforeseen reason at the time of purchase and Gibson's will notify you when the item is received or will sell you a comparable item at a comparable discount. . . satisfaction guaranteed always.

**PLAYTEX
DISPOSABLE
BOTTLES**

**2\$3
FOR 3**

The number 1 disposable feeding system. 100 count. Stock up today.



**ENFAMIL OR
SIMILAC BABY
FORMULA**

**199
6 PACK**

Enfamil ready-to-use or with iron. 6 pack of 8 ounce cans. Or Similac ready-to-eat or with iron, 6 pack of 8 ounce cans. Buy now!



YOUR SATISFACTION IS ALWAYS GUARANTEED

HWI
Only Ones.

SALE LASTS
10 BIG DAYS

Today's
Home

SUMMER SALE

Most items in this sale circular at reduced prices



SAVE
12.07!



PARK POST CORPORATION

PICNIC TABLE FRAME

REG.
34.95

2288 IN CTN

- Easy to assemble (less lumber)
 - Sturdy, rigid steel frame
 - Ornamental scrolls, antique finish
 - Rust resistant hardware
 - Disassembles for storage
- 228 667/ FIESTA(0-1)



DO IT YOURSELF
AND SAVE!



FIRST RELEASE
SEAT BOARDS
FROM LEGS



THEN TURN TABLE
OVER AND REMOVE
BRACE ROD FROM CUP



ALL NEATLY
FOLDED READY
FOR STORAGE

©HWI
Mr. Friendly



Black &
Decker

VALUE-PLUS™

3/8" CONVERTIBLE DRILL

SALE
PRICE

2388

HAMMERING ACTION
DRILLING ACTION

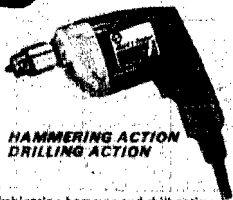

- Combination hammer and drill action
 - 1/3 HP; double insulated
 - Detachable 9 ft. cord
- 356 206/7928(1-5)

ROOF VENT

REG.
7.19

427

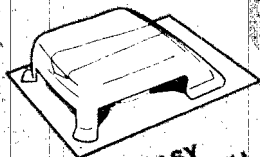

EASY
TO INSTALL

- Aluminum, with screen
 - Base size 18 1/2" x 18 1/2"
- 120 327/405(0-12)

HWI

BONUS

DEAR-KAT PRODUCTS, INC.

BOLT & SCREW ASSORTMENT

REG.
2.89

197



- Popular sizes in separate compartments
 - Bright zinc plated
- 700 254/120(6-72)

HWI

BONUS

WIRE PAINT STRIPPER YOUR CHOICE LIGHT OR HEAVY DUTY

REG.
9.95

597
EACH



AI
Industries

- Tempered spring fingers
 - 1/4" shank
 - Removes paint in minutes
- 312 101/WS-LD(0-5)
311 861/WS-HD(0-5)





SUMMER SALE

SHOP AND SAVE TODAY!

MR. FRIENDLY'S GUARANTEE OF GOOD SERVICE

- Sales people well trained in product knowledge ready to help answer your questions
- If we don't have the item or service part you need, we will make every effort to secure it for you.
- Advice on many do-it-yourself projects is available: electrical, plumbing, painting, etc.
- We are interested in your welfare.



HVI PLASTIC ROOF CEMENT

GALLON	5 GALLON
SALE PRICE	SALE PRICE
217	847

- Asphalt-based adhesive
 - Won't crack, crumble, shrink
 - For roof, metal gutters, flashings
- 103 667/300(0-6)
103 676/300-5G(1-48)

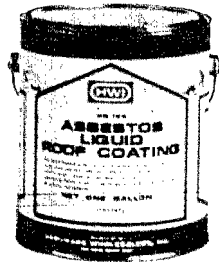

HVI ASBESTOS FIBER ROOF COATING

GALLON	5 GALLON
SALE PRICE	SALE PRICE
217	797

- Forms tough, waterproof surface
 - Renews dried-out cracked asphalt shingles and roofing
- 103 587/100(0-6)
103 596/1005G(1-48)

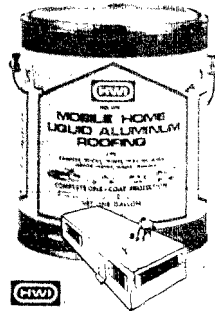

HVI ALUMINUM ROOFING FOR MOBILE HOMES

GALLON	5 GALLON
SALE PRICE	SALE PRICE
497	2288

- Complete one-coat protection for travel trailers, mobile homes, campers too
- 101 366/675(0-6)
100 633/675 5G(0-1)

4 MIL. 8 FOOT x 100 FOOT CLEAR POLYETHYLENE



SALE PRICE **888**

- Lightweight but durable
 - Soft and pliable
 - Use to cover, store, protect
 - Easy-store, easy-cut roll
- 102 891/8x100(0-1)

SELF-SEALING ROOFING SHINGLES

Neat, attractive roofing shingles with self-sealing adhesive that bonds the overlapping shingles for wind and storm-tight snugness. Save during our Summer Sale.

SEE MR. FRIENDLY FOR FREE ESTIMATES!

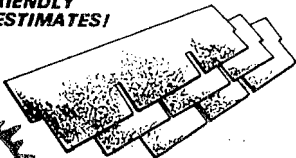

\$100 OFF

PER SQUARE DURING OUR SALE

CASH & CARRY

SQUEEGEE BRUSH COATER

- Brushes sealer into cracks and crevices
 - Squeegee spreads sealer evenly on surface
 - Threaded handle hole
- 772 248/4522(1-12)

REG. 2.19 **166 LESS HANDLE**



Wright-Bernet

48 INCH THREADED HANDLE

REG. 1.29 **97¢**

- Plain sanded finish
- 48" long

791 904/0248(1-12)
Wright-Bernet

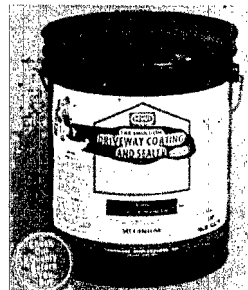

HVI DRIVEWAY SEALER

5 GALLON SALE PRICE **697**

- Restores old driveways; seals new driveways
 - Provides hard, easy-to-clean surface
 - Easy to apply; dries fast
- 107 770/740(1-48)

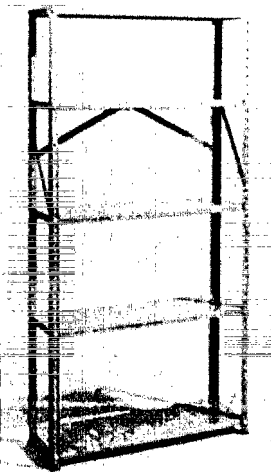

ALL-PURPOSE STEEL SHELVING

4 SHELF UNIT
SHELVES 12" x 36"
ADJUSTS 21" TO 60" HIGH

REG. 15.85 **997**
IN CTN.

5 SHELF UNIT
SHELVES 12" x 36"
ADJUSTS 37" TO 73" HIGH

REG. 19.85 **1297**
IN CTN.

- Extra heavy gauge steel shelf units
- Versatile, for use anywhere
- Ribbed posts, ribbed shelves, and sway braces provide added strength
- Adjustable shelf height
212 031/FS12-4(0-1)
212 040/FS12-5(0-1)

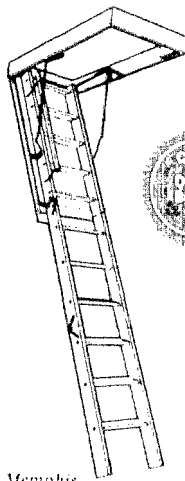

Memphis

EASY-TO-INSTALL FOLDING STAIRWAY

CHOICE OF OPENING SIZES

22" x 54" OR 25 1/2" x 54"

TO 105" CEILING HEIGHT

REG. 40.95 **3077**
IN CTN.

TO 120" CEILING HEIGHT

REG. 45.55 **3247**
IN CTN.



- Completely assembled and ready to install
- 3-1/8" steel ladder rods under every tread
- Eloquent treads, rail handle
- Top grade southern pine; piano hinge
163 735/22x54x105(1-5)
163 717/25 1/2x54x105(1-5)
163 726/25 1/2x54x120(1-5)
163 744/22x54x120(1-5)

NOTICE REGARDING POSSIBLE CHANGE IN AVAILABILITY OF ADVERTISED GOODS AND IN QUOTED PRICES

Due to the fact that this piece is not prepared by this retail dealer, but by our wholesalers, who have warehouses at Fair Wayne, Indiana; Cape Girardeau, Missouri; Dixon, Illinois and Medina, Ohio, and because this piece is prepared several months in advance of the actual sale period, all of the items advertised may not be immediately available on demand of our store, due either to sales above reasonable demands, or other circumstances beyond this retailer's control. Also, unforeseen circumstances may cause a price to change without notice, certain items may not be available at all, or a substitution will be suggested. All the prices stated, both regular and sale, are HWI suggested. Each HWI store sets its own prices. Its sale prices are frequently lower and never higher than shown.

This store and our warehouses endeavor to avoid all such changes whenever possible, but sometimes we have no control over manufacturers and their problems. Therefore, this retailer will gladly issue a "raincheck" for any advertised item not available on demand, which will be good for purchase of the particular item at the advertised price, when additional inventories of the item are received. We reserve the right to limit quantities. Early shoppers will find the best selection. The prices quoted herein are subject to change due to possible printing errors.

HEAVY DUTY HOUSEHOLD 5 FOOT WOODEN STEPLADDER

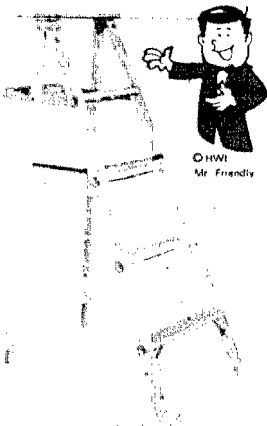

©HWI
Mr. Friendly

REG. 22.95 **1497**

- Top quality household ladder
- Type II duty rating
- Strong and sturdy enough for light commercial use
- Dowel braced back legs, fully rodded steps for extra support
791 600/5FT(0-1)

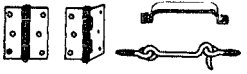

SCREEN DOOR SET

REG. 3.49 **297** Wright
Products

- Includes hinges, 2 1/2" hook and eye, handle pull and door spring
217 376/23CAD(1-25)

8" x 10" SHELF BRACKET

REG. 1.02 **77¢**

- One piece girder type bracket
- Angled slightly over 90° to keep objects on shelves
211 149/110-8x10(20-100)

National

18 INCH x 24 INCH
2 LITE
SLIP HEAD
SASH UNIT

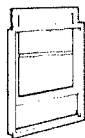

REG. 20.25

1588

- Primed pine sash unit
- Ideal for garage, attics, or farm buildings
160 140/18x24(1-24)

DELUXE LAUAN MAHOGANY SHELVES

8 INCHES x 24 INCHES
READY TO FINISH

REG. 2.09 **137**

OTHER SIZES
AVAILABLE

- Smoothly sanded; ready to finish
- Perfect for garage, basement, workshop, storage areas
219 720/8x24(1-12)

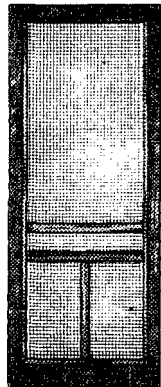

BONUS

2'8" x 6'9" x 1-1/8"
WOODEN
SCREEN DOOR

- Unfinished seasoned pine
- Aluminum screen cloth
- Pine support strips
160 881/28x69(1-12)

OTHER
SIZES
AVAILABLE

1555

McPhillips

HWI
The Friendly One®

BONUS

Garage Magic
REG. 2.39
167

• Cleans grime and oil from garage driveway
• Just spray on
• 13 ounces
810 242/810(1-24)

BONUS

Flat Latex House Paint
REDWOOD STAIN

297
GALLON

2 GALLON

ACRYLIC FLAT LATEX HOUSE PAINT

SALE PRICE **997**

Flat Latex House Paint

• All purpose exterior finish for wood and masonry surfaces
• Acrylic latex formulation
• One coat coverage. Spreads easily
• Soap and water clean up
775 498 941W/1111 48

GOOD QUALITY!

BONUS REG. 6.99

RED LATEX BARN PAINT

Latex Barn Paint

- Farm tested
- Lead free
- Easy to apply
- Soap and water clean up

782 399/3806 (0-4)

397 GAL.

5 GALLON REG. 32.95 **1888**

791 806/3806(0-1)

BONUS

2 1/2 INCH WOOD SCRAPER

SALE PRICE **97c**

• 11" long scraper
• Gives good leverage
314 430/HW(0-10)

SAVOGRAN

"STRYPEEZE" PAINT REMOVER

REG. 2.69

SALE PRICE **144**

Strypeeze
Paint & varnish remover

- Semi-paste
- Will not harm wood grain
- 1 quart

776 398/STRYPEEZE (1-8)

1 1/2 INCH SASH BRUSH

SALE PRICE **188**

- 100% polyester bristles
- Use with any type of paint

784 468/TY3215 (1-12)

MEDIUM WEIGHT PLASTIC 9" x 12" DROP CLOTH

SALE PRICE **67c**

- Transparent plastic
- Protection against water, oil, paint and stains

781 443/200(1-24)

ACRYLIC LATEX CAULK

SALE PRICE **88c**

- Elastic, non-staining
- Will not split or crack
- Withstands heat and cold
- Soap and water clean-up
- 11 ounce

791 628/HW(0-24)

4" WALL BRUSH

SALE PRICE **244**

- 100% polyester bristles
- Use with any paint or any surface

784 921/TY5640 (1-12)

BONUS

MASKING TAPE

3/4" x 60 Yds.

SAVE NOW!

SALE PRICE **47c**

- All purpose tape
- Sticks quickly
- Sticks firmly

781 443/200(1-24)

BONUS

LATEX CAULK

SALE PRICE **77c**

LATEX CAULK

- Flexible latex adhesive
- For interior/exterior use
- Use under latex and oil paints
- 11 ounce

784 814/HW(0-24)

Mr. Friendly

BONUS

PLASTIC PAINT TRAY LINER

SALE PRICE **19c**

- 9" disposable liner
- No mess
- No clean-up

788 028/LINER (0-48)

REG. 49c

HEAVY DUTY CAST ALUMINUM
CHAR BROIL PORTABLE

GAS GRILL

WITH STEEL LP TANK

Get great cook out flavor with the ease and dependability of gas. Avoid costly installation charges with this portable unit. Heavy duty black cast aluminum assures many years of trouble free service. Turbo Air venting on back to rotate heat for more even cooking. Char rock included. Ideal for family size meals.

- 14" x 22" cooking area
- 14 shaped stainless steel burner
- 1 color phenolic wood grain tray
- 4 sturdy cast aluminum legs
- Heavy steel base with big tripod wheels
- 21 lb. capacity LP tank regulator and fittings

W. C. Bradley

REG.
149.95

109⁹⁴



The Friendly Ones

SAVE NOW
DURING OUR
SUMMER
SALE

VOLTA

THE ELECTRIC MATCH

FOR GAS GRILLS & BURNERS

REG. 7.99
4.97



D.C. Vermae

- Trigger quick—needs no fuel, flint, batteries
 - Lights any combustible gas instantly
 - Cuts home appliance gas consumption—eliminates pilot lights
 - Electro-mechanical sparking mechanism tested for years of service
- 836 734 (R1-24)

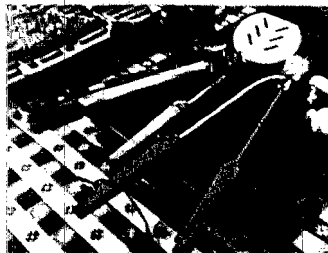

EKCO

5 PIECE

BARBEQUE SET
WITH TRAY

REG. 11.95

788

- All-in-one set—tools & tray
 - Turner, fork, tongs, brush with hardwood handles
 - Black enameled tray with wood-grain side handles
- 808 852/C5805(1-6)

14 INCH x 23 INCH

CHARCOAL GRILL

REG. 79.95

5788

IN CTN.

- For years of fun-filled outdoor cooking
 - Heavy cast aluminum body and hood
 - Four position steel fire grate
 - Front unloading ash drawer
 - Hardwood cutting board
- 804 026/CK120(0-1)

W. C. Bradley



21 INCH STEEL

SMOKER GRILL

REG. 48.95

3797

IN CTN.

- Durable heavy gauge steel
 - 1" tubular legs with wide track wheels for portability
 - Adjustable draft controls
 - Wood handles for cool, easy handling
 - Four position fire pan and ash catcher
- 831 283/8058(0-1)



SAVE
10.98!

BONUS Marsh Allen
FOLDING STEEL MESH TABLE

REG. 4.95

322

- Versatile, 1 piece folding table
 - White; 16" x 16" top; 17" high
 - Can be arranged as outdoor cocktail table, corner table or individually for screening
- 836 705/162810 (2)

SAVE NOW DURING OUR SALE!

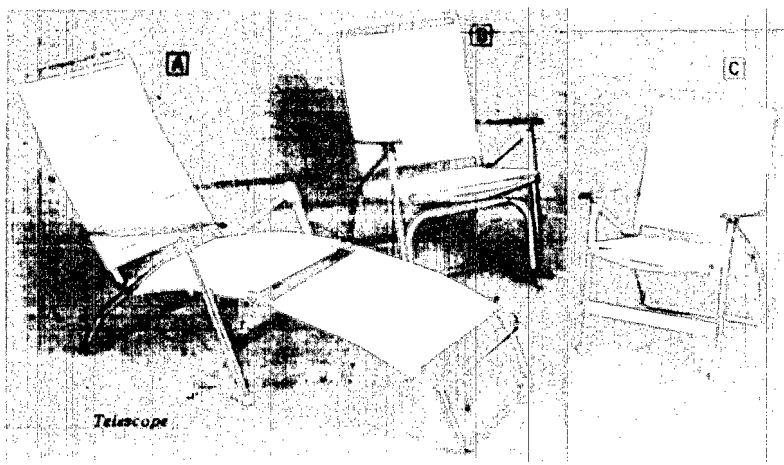

WHITE TUBE LAWN FURNITURE

A CHAISE REG. 45.95 **34⁸⁸**
 B ROCKER REG. 35.95 **26⁸⁸**
 C CHAIR REG. 25.95 **19⁸⁸**

- Piece of sweeping of plastic tubing for easy, comfortable outdoor terrace living
 - Built-in cushion of all-weather fabric, removable, 100% high outdoor fabric
 - Chair for indoor and outdoor heated seating material
 - Adjustable, fold, compactly
 - Adjustable, four position of a set
 - Low profile for shade for patio, porch, poolside
- 836 482/98160 (2) 836 482/11160 (2)
 836 202/98160 (1)

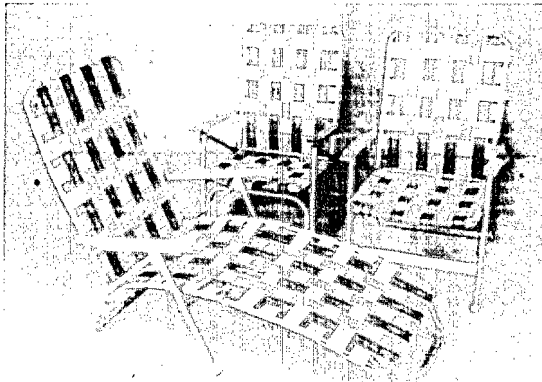

Telescope

DELUXE MULTI-COLOR LAWN FURNITURE

CHAISE REG. 33.95 **24⁹⁴**
 ROCKER REG. 29.95 **22⁹⁴**
 CHAIR REG. 20.95 **15⁹⁴**

- Roomy, full size outdoor furniture
 - 1" special alloy high strength aluminum frames
 - Durable outdoor finish on hardwood arms
 - 2 1/2" heavyweight multi-color webbing
 - Adjustable, four position chaise
 - Fold compactly
- 802 457/9501-9(0-1) 802 466/6501-9(0-1) 802 448/7501-9(0-2)

MULTI-POSITION CHAISE LOUNGE

REG. 19.95 **13⁹⁷**

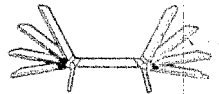

BOTH ENDS ADJUSTABLE - USE AS CHAISE, SUN COT, LOUNGE OR BEACH CHAIR

SAVE 5.98!

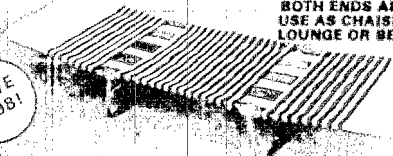

- Versatile - great for chaise, sun cot, lounge, beach chair
 - Designed for comfortable indoor/outdoor use
 - Rugged tubular frame; all weather poly tubing
- 815 737/C46 FANGS&WHITE(0-1)

KELLER

YELLOW DIRECTOR'S CHAIR

REG. 24.95 **19⁹⁴**

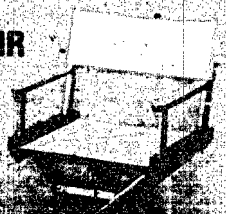

802/1100 YELLOW(0-1)

Klean-Em-All SEWER & SEPTIC TANK CLEANER



SALE PRICE **466**
GALLON

- Removes obstructions from septic tanks
- Pour into drain - starts to work in 30 minutes
- One gallon 407 385/1Gal(1-4)

Alexander

PLUMBING PROBLEMS?

FAUCETS DRIP?
DRAINS WON'T DRAIN?

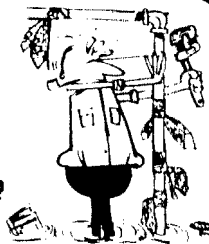

PAK A WASHERS BONNET WASHERS STEM PACKING PLUNGERS



We have a complete line of plumbing aids for the Bath, Kitchen, or Laundry Room. Whatever your plumbing needs, shop "The Friendly One" for Quality, Service, Satisfaction and Value you can depend on.

Shop The
Friendly One!



COUPON



Rockwell
STEP-BY-STEP
PLUMBING
GUIDE

WITH COUPON

REG. 1.00

66¢

- Repair and replacement aid
- How to use plumbing tools
- Joint soldering instruction 400 088/9702.1(12-192)

Additional or without coupon 88¢



FRANKLIN FAUCET SEAT REAMER

SALE PRICE
388

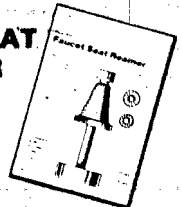

- Re-seats faucets like new
- Fits all types faucets with either inside or outside threads
- 3 cutters; sizes for 3/8", 1/2", 5/8" faucet seats 411 646/4530(1-6)

25 FOOT DRAIN AUGER

SALE PRICE
388

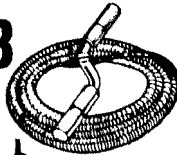

- Works where chemicals fail to clear drains
- Easy-spin handle
- Quick, smooth operation 408 017/25NCA (11-12)



General Wire

SEALED TUB & WALL TAPE



- Sealed tub and wall tape
- Easy to apply
- 15' long, two-piece roll 438 629/15(1-6)

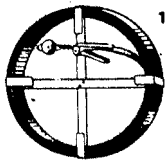

1/2" x 1/16" x 50'
FLAT STEEL
SEWER
ROD

SALE PRICE
1333

General Wire

- For quick, efficient cleaning of medium size drain pipe and sewers
- Metal two piece grip handle and roller spear head; high carbon oil tempered steel 408 035/50BH(0-1)

BATHROOM PLUNGER

SALE PRICE
66¢

407 348/6-103(0-12)

Radnor Spec.



1/2" x 40"
PIPE THREAD TAPE

29¢

- DuPont® Teflon tape
- Wrap tape around pipe threads for leakproof joint 426 934/1/2x40(12-216)

Genova DO-IT-YOURSELF VINYL PLUMBING

SAVES TIME
AND MONEY!

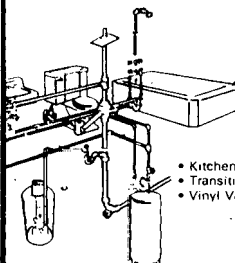

Cuts with
a handsaw

- Kitchen; Bath
- Transition Fittings
- Vinyl Valves



Cements in
seconds

- Do it yourself and save
- Chemical resistant - won't rust, rot or corrode
- Complete line of pipe and fittings, cements & cleaners

COUPON

FRANKLIN
FIX ALL
PLUMBING
REPAIR KIT

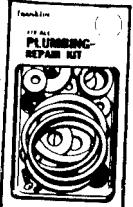

WITH COUPON

99¢

REG. 1.99

- Contains 42 rubber, leather, fibre, brass repair items for faucets, toilets, traps and valves 411 619/2369(1-6)

Additional or without coupon 1.33



BONUS

FRANKLIN
DELTA® FAUCET
REPAIR KIT



REG. 2.49

188

- Genuine Delta® factory parts
- For use in all single handle Delta® ball faucets
- Nine piece assortment 423 697/4503(1-24)

3 PIECE BATHROOM FIXTURE SET

COMBINATION PRICE
124⁸⁸



TOILET COMBINATION

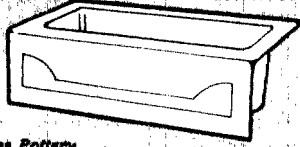

BATH TUB

Peerless Pottery

TOILET COMBINATION

- Made of heavy duty white vitreous china to last a lifetime
- Quiet operating reverse trap design
- (Lavatory - separate order) 470 480/880(0-1) 470 481/210(1)

SALE PRICE **39⁸⁸**

LAVATORY

- Gracefully designed white acid resistant porcelain for ease of cleaning
- Concealed front overflow, self rimming bowl is 17" deep by 20" wide
- 438 407/2446(0-1)

SALE PRICE **18⁸⁸**

BATH TUB

- Modern, functional recessed design; white porcelain-enamel finish
- One-piece construction of heavy gauge steel; 60" x 30" x 15 1/2" high
- 400 202/2380RH(0-1) 400 211/72361LM(0-1)

SALE PRICE **74⁸⁸**

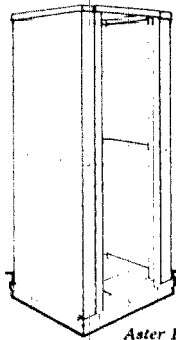

'POLY-PRO' SHOWER STALL

REG. 154.99

119⁸⁸ IN CTN

Aster Products

- Rustproof, joint-free plastic shower stall
- Perfect choice for basement, vacation home
- Includes floor, valves, shower head, anodized aluminum handrail, soap dish, shower rod, curtain and hooks
- Overall size 32" x 32" x 74 1/2"
- 437 054/1820(0-1)

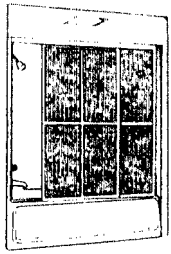

KINKEAD INDUSTRIES

TEMPERED GLASS TUB ENCLOSURE

SALE PRICE **48⁸⁸** IN CTN

- Translucent tempered glass panels in aluminum frame
- Opens smoothly on nylon rollers with ball bearings
- Installs easily; blends with any decor
- For 59-5/8" maximum width opening; 56" high
- 435 504/600 60(0-1)

WHITE WOODEN BATHROOM SEAT

Magnolia

SALE PRICE **4⁴⁴**

- Gleaming enamel finish
- Non rust poly hinges
- Molded seat
- 412 814/M100(0 61)

DELUXE PLASTIC BATHROOM SEAT

Magnolia

SALE PRICE **8⁴⁴**

- Marbleized plastic
- Concealed rust-resistant hinges
- 425 597/M450(1-6)

SOFT BATHROOM SEAT

Magnolia

SALE PRICE **11⁸⁸**

- Foam padded cover and seat ring of easy to clean leather-grained vinyl
- Top mount hinges are non-corrosive
- 404 618/M3000(1-6)



68-1/8" x 24" STYRENE SHOWER DOOR

SALE PRICE **42⁸⁸** IN CTN.

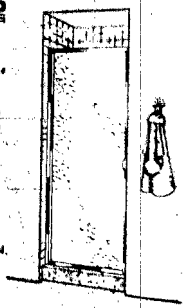

- Swinging shower stall door
- Safety-glazed plastic panel in etched silver-finish aluminum frame
- Continuous hinge mechanism
- 400 015/850RA-24(0-1)

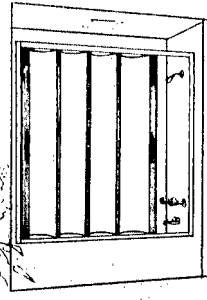

KINKEAD INDUSTRIES

SHOWER FOLD TUB ENCLOSURE

SALE PRICE **39⁸⁸** IN CTN.

- White opaque polyethylene shatterproof panels
- Silver-anodized satin-finish frame and trim
- Easy, noiseless operation on special rollers
- Magnetic catch holds panels watertight when closed - holdback latch keeps panels open for easy access
- 58-5/16" high x 60" wide
- 412 850/120-60(0-1)

CLOSET INSTALLATION KIT

REG. 9:99

79⁷

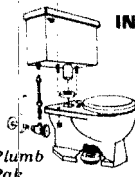

- Includes wax bowl ring, supply tube & valve and adapter for installing closet combination unit
- 436 987/MKAWPT (1-5)

DELUX LAVATORY FAUCET WITH POP-UP 4 INCH CENTER



REG. 25.98

21⁸⁸ Delta

- Trouble-free, washless design
- Crystal handles
- 400 838/2522 (1-12)

DELUX TWO-HANDLE TUB SPOUT



REG. 26.98

24⁸⁸ Delta

- 4" centers
- Metal tube spout
- Crystal handles
- 414 288/2810 (1-12)

DELUX TUB & SHOWER ASSEMBLY



REG. 36.98

32⁸⁸ Delta

- Diverter spout
- Crystal handles
- Includes shower head, arm & trim plate
- 414 216/2940 (1-12)

TIP-TOE DRAIN WITH OVERFLOW

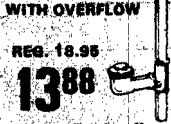

REG. 18.95

13⁸⁸ Rockwell

- Seals and releases bath water at the touch of your toe
- 404 867/16-710 (1-12)

Miami Carey



14" x 19" MIRROR CABINET

REG. 10.95

797

- Surface mounted for installation ease
- All steel cabinet, two metal shelves
- White baked-on enamel finish
- Overall size 14" x 19" x 4 1/2"
- 401 149/CSW-58-14(1-4)

Miami Carey



GOLD & WHITE MIRROR CABINET

REG. 34.95

2888

- Faced swing door cabinet
- Two adjustable glass shelves
- Plate glass mirror
- 14" x 20" x 3 1/2" rough wall opening
- 408 723/CRP-315-20(0-1)

TRIPLE DOOR MIRROR CABINET WITH LIGHT FIXTURE & BULBS

COMBINATION REG. PRICE 169.97

12488

CABINET ONLY LIGHT FIXTURE BULBS

77.88
44.97
3.59
EACH

- Elegant gold tone decorator light and walnut wood tone on cabinet
- Overall size 30" x 31-3/8" x 5"; surface mounted
- Easy to install
- 433 844/CSP-935-30(0-1)
- 437 138/D-110(0-1)
- 503 048/40GM/W(1-6)

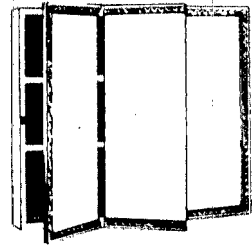
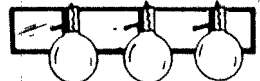

Miami Carey

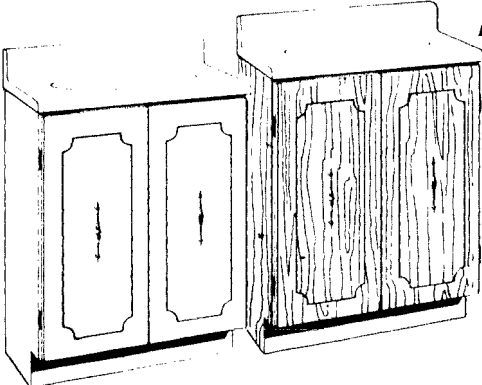

Industrial Dimensions, Inc.

"CORONATION" DRIFTWOOD OR WALNUT VINYL FINISH VANITY

WITH MARBELUSTRA TOP & INTEGRAL BOWL

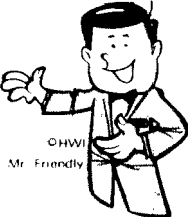

OHW Mr. Friendly

25" x 22" TOP & BASE COMBINATION

- Fine line carvings on front panels and distinctive pulls on self closing doors
- Heavy duty vinyl lining is easy to care for and long lasting

SALE PRICE **6888** IN CTN

407 562 /C2124DW B(0-1) 407 802 /C2124WLB(0-1)
407 580 /C24DW D(0-1) 407 893 /C24WL DR(0-1)
415 606 /25x22TOP(0-1)

19" x 17" WHITE TOP & BASE

- White base with gold accent trim
- White and gold top

SALE PRICE **3988** IN CTN

431 483 /PR1816WH(0-1) 413 010 /19x17TOP(1-4)

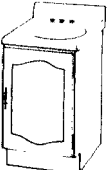

VANITY INSTALLATION KIT

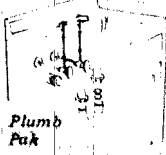

REG. 15.95

1288

Plumb Pak

- Contains all necessary parts to install vanity faucets & drain connections to wall outlets
- Includes easy to follow instructions
- 438 998/MKA2PT(1-5)

"PREMIER" DECORATOR LAVATORY FAUCETS

POLISHED OR ANTIQUE BRASS

YOUR CHOICE

Artistic Brass SALE PRICE **4444** EACH

- Customize your vanity installation
- Clear lucite handles with brass rose accent
- 4" lavatory centerset with pop-up drain
- 436 111/4PLS PB(1-8)
- 438 166/4-PLSAB(1-8)

FRANKLIN PERSONAL SHOWER FOR FAUCETS



SALE PRICE **988**

- Add a portable snap-on shower to your kitchen or lavatory faucet
- 59" flexible vinyl hose
- Instant aerator connector
- 401 577/8207(1-3)

FRANKLIN DELUXE PERSONAL SHOWER FOR TUB



SALE PRICE **1988**

- Wherever there's a tub spot you can install a shower
- 59" flexible chrome plated hose
- Push-button flow control valve
- Includes tub spout with diverter
- 403 960/8253(1-3)

BONUS

FRANKLIN "WATER SAVER" SHOWER HEAD

A Good Shower Head at a Low Price!



REG. 3.39

244

- Uses up to 50% less water
- Fits all 1/2" shower arms
- 419 023/8060(1-6)

WAYNE CAPTIVE AIR WATER SYSTEMS

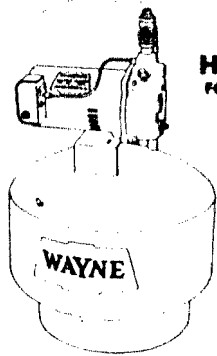

HI-LO JET SYSTEM
FOR DEEP OR SHALLOW WELLS

SHALLOWELL SYSTEM
FOR WATER DEPTHS TO 25 FEET

CHECK OUR EVERYDAY LOW PRICES!

- 1/2 HP pump converts easily for shallow or deep (to 90 ft.) water levels
- Simply add proper jet to pump
- Efficient precharged 30 gallon captive air tank eliminates standard air volume control
- Fewer stops and starts extends life of pump
- Cuts lifetime cost of water

- 1/2 HP pump and precharged 12 gallon captive air tank
- Provides an efficient, trouble-free low cost system
- Water in the tank never touches steel and is delivered clear & clean

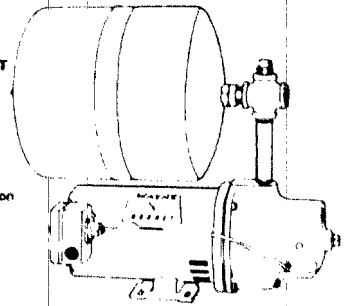

413 831/CJX4-30PCA(0-1)

419 407/SJD3 WX12(0-1)

Cresline POLY PIPE



1/2" x 100'

3/4" x 100'

REG. 8.00 **633**

REG. 12.50 **933**

1" x 100'

REG. 20.00 **1533**

FULL ROLLS ONLY AT THESE SALE PRICES

- Pressure rating 100#; NSF approved
 - Rust-proof high grade polyethylene
 - For deep well piping, lateral water lines, swimming pools, crop irrigation
- 424 456/1/2-100(0-1)
424 464/3/4-100(0-1)
424 473/1-100(0-1)

Mr. Friendly

SEE US FOR ALL YOUR PLUMBING NEEDS



WAYNE PRESSURE GAUGE

- Replace your old water system gauge
- 0-100#; 2" dial
- 1/4" pipe connection

SALE PRICE **244**

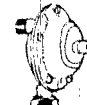

WAYNE AIR VOLUME CONTROL

- Fits tank sizes up to 42 gallon
- 1/4" connection

SALE PRICE **397**



WAYNE SQUARE-D PRESSURE SWITCH

- Standard pump replacement switch
- Pre-set at 20#-40#; can be adjusted
- For up to 2 HP motors
- 1/2" pipe connection

SALE PRICE **644**

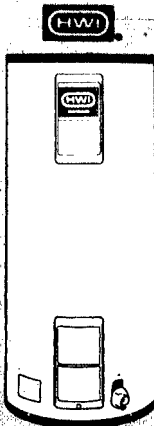
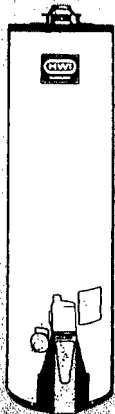

WATER HEATERS

42 GALLON ELECTRIC HEATER

- Built to fill your family's hot water needs
- Double element with fully automatic control
- Glass-lined tank insures clean water and longer life
- 5 year limited warranty on tank

30 GALLON GAS HEATER

- Efficient gas burner for dependable hot water service
- Fully automatic control
- Glass-lined tank insures clean water and long life
- 5 year limited warranty on tank

CHECK OUR EVERYDAY LOW PRICES!

WATER HEATER REPAIR PARTS UPPER THERMOSTAT

SALE PRICE **933**

- Replacement thermostat with reset button
- 4 pole 410 308/EWH4-4(1-10)

ELECTRIC WATER HEATER REPLACEMENT ELEMENT

SALE PRICE **633**

- For current electric water heaters using thread-in element

ELEMENT ADAPTER KIT

SALE PRICE **188**

- Adapts threaded element to water heaters using square or round flange installations



4 PIECE REDWOOD SET

- Clear California redwood for lasting beauty
 - Rich and rugged set includes 7' long chairs with wheels and 3 settings, two club chairs, and handy end table
 - All-weather vinyl cushions in a beautiful floral design
- 811 447/230(0-1)

REGULAR 149.95
EACH SET

YOUR CHOICE **94⁹⁷** EACH
IN CARTON
FOR YOUR CONVENIENCE

SAVE NOW!



Grand Lodge

6 Piece Redwood ROUND TABLE SET WITH LAZY SUSAN

- Picnic-perfect redwood set has room for the whole family
 - 48" round table with 4 curved 36" benches that seat up to eight
 - Convenient movable lazy-susan-center-for-outdoor dining ease
- 804 071/50-4(0-1)

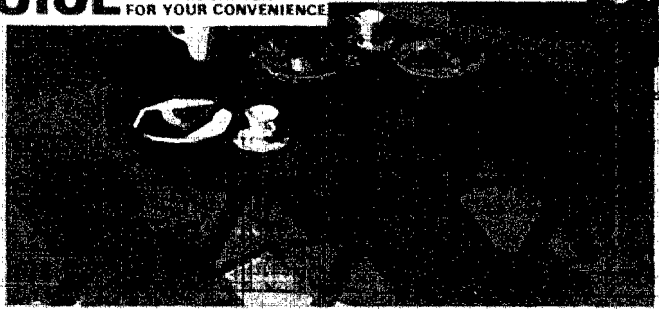

5 FOOT "SWING-A-LAWN" PORCH SWING WITH FRAME



JR JACK POST CORPORATION

REG. 89.90
VALUE

BOTH FOR 64⁸⁸
IN CTN.
FOR YOUR CONVENIENCE

SAVE 25.02
NOW!

60 INCH ROUND UMBRELLA TABLE COVER WITH ZIPPER

REG. 2.95
1⁹⁷

- Durable, wipe-clean vinyl
 - Free slide, rust resistant zipper
 - Cotton fringe
 - 72" diameter, fits up to 50" round table
- 803 973/793(1-24)

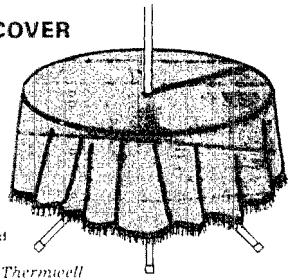

Thermocell

5 FOOT LIAR'S BENCH

READY TO FINISH **JR** JACK POST CORPORATION

- Built for long-lasting enjoyment
 - Comfortable seat and back rest of weather-resistant hardwood
 - Strong tubular legs in wrought iron finish
- 826 486/FRLB(0-1)

REG. 54.95
39⁹⁷
IN CTN.

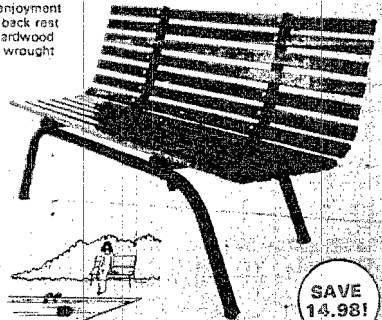

SAVE 14.98!

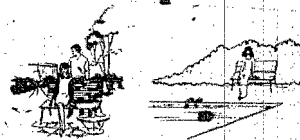

SWING ALONE

REG. 54.95
39⁹⁷
IN CTN.

- Perfect for homes without a porch
 - Swing and relax on a porch swing
 - 5 ft. long weather-resistant hardwood swing
 - Sturdy metal framework and stand
 - Pre-drilled for easy assembly
 - Includes hardware
- 811 483/FRLS(0-1) 811 820/FRSF(0-1)

FRAME ALONE

REG. 34.95
27⁸⁸
IN CTN.

Franklin
LAWN DART SET

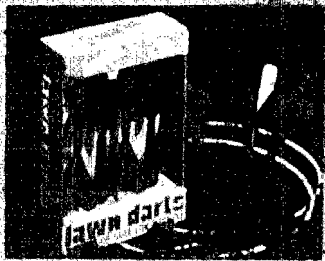

REG. 4.99 **327**

- A skillful outdoor game for adults not a kid
- Includes 160-piece lawn darts and two target rings
- 821 489/3210(1-24)

CHILD SIZE
PICNIC SET REG. 14.99 **1488**

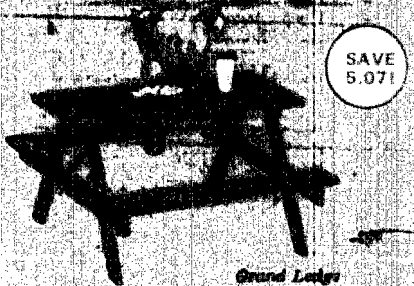

SAVE 5.07!

Grand Lodge

- Mini-size picnic set for the kids
- Durable, quickly removed grass for outdoor meals or play-time indoors
- One piece table and benches, 36" x 18" x 12"
- 804 036/720(1)



DB JACK, PAUL CORPORATION

17 FOOT FLAG POLE KIT

REG. 34.95

1994
IN CIN.

- Enhance the natural beauty of your home
- Three-section white finish tubular steel pole
- Includes 3' x 6', 50-star flag, eagle, pulley, nylon rope and hardware
- 825 646/WR17(0-1)

CRWD
BONUS

BADMINTON/VOLLEYBALL GAME SET

994

REG. 14.95

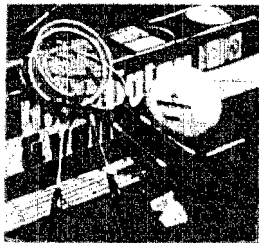

- Four steel shaft rackets
- 7/8" steel poles with stakes and rope
- 20' x 2' net
- Two shuttlecocks
- Official size volleyball
- 823 595/3252(1-6)

CRWD
BONUS

GULF TORCH FUEL

288
GALLON

- For use in patio and garden torches
- Easy to light
- Clean burning
- 836 280/341(0-4)

FIREFLY PATIO TORCH

REG. 7.95

588
PAIR

- Polished aluminum
- 4' tall pole
- Includes wick and snuffer cap
- 5 hour burning capacity
- 823 602/SAS(1-12)

Patio Products



CRWD
BONUS

PIE IRON

377

REG. 6.39

Minnesota Apollo

- Ideal for campfire cooking
- Solid cast aluminum
- Toasts sandwiches, M&E over open fire, barbecue grill, fireplace, or stove
- 813 997/SR11(1-12)

48 QUART ICE CHEST

SAVE 14.96!

REG. 39.95

2499

igloo

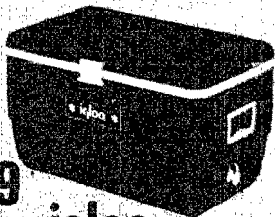

- Extra-large size carries a heavy load
- Rugged plastic won't chip, scratch or dent
- Keeps both food and beverages cold
- Won't absorb odors or stains
- Includes removable food tray
- Insulated lid makes a great extra seat
- 804 721/70(0-1)

igloo 13 QUART COOLER

REG. 18.95

1088

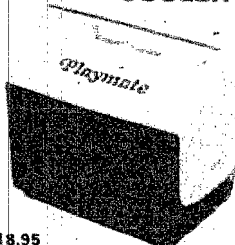

- The Ideal "take-along" for picnics, to the beach, anywhere
- Holds 18 iced-down cans
- Swing-down top
- Push button lock
- Sarg-grip handle
- 800 592/1371(0-1)

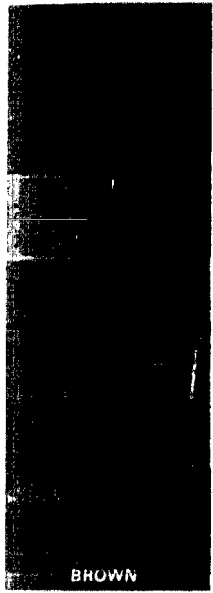

BROWN

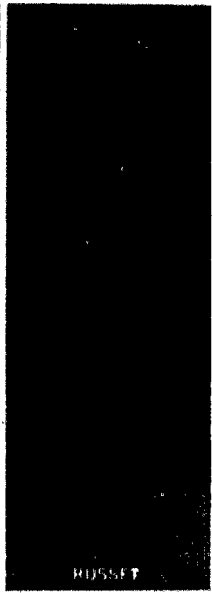

RUSSET



WHITE

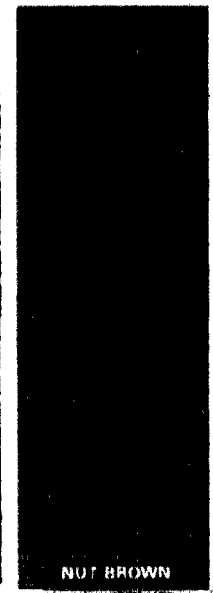

NUT BROWN



WOODMOSS

MASONITE Cedar Mill 4 FOOT x 8 FOOT PANELING

CHOICE OF COLOR

SALE PRICE **588**

- Embossed texture compliments any setting
 - Men-made finish on Masonite hardboard; 5/32" thick
 - Intended for application over existing walls or solid backing
- 107 847/352BROWN(1-75)
107 850/351RUSSET(1-75)
107 869/350WHITE(1-75)

GeorgeFlectic Forestflair

4' x 8' x 5/32" PANELING

CHOICE OF COLOR

SALE PRICE **757**

- Search the vibrant charm of a softly sunlit forest into every panel of the room
- 100 891/448 NUTBROWN(0-50)
100 891/448 WOODMOSS(0-50)

BONUS REG. 2.39

PANEL MAGIC PUMP SPRAY

167

• Cleans and beautifies paneling, woodwork

• Non-aerosol, 1 pint

601 771/LPM8(6-24)



BONUS

Monaco Ceiling Tiles & Panels

• Stippled pattern

• 1/2" thick

103 523/285(1-30)

103 499/185(1-40)

12" x 12" TILE SALE PRICE **23¢** EACH

2' x 4' PANEL SALE PRICE **147** EACH

IN FULL CARTON ONLY AT THIS SALE PRICE

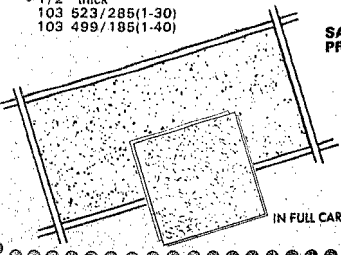

@lotex

2' x 4' WAVERLY PANEL

CLASS A FIRE RESISTANT

SALE PRICE **187** EACH

• White, non-directional pattern

• Mineral fiber tile

• Washable lay-in panels

103 505/190(1-40)

IN FULL CARTONS ONLY AT THIS SALE PRICE

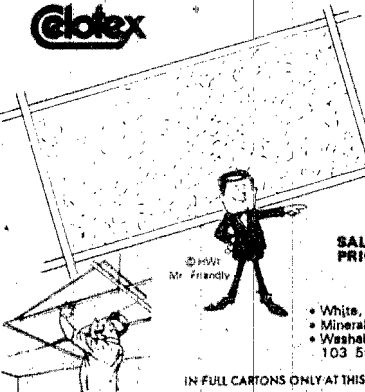

Power Products Co.

FLUORESCENT GRID LIGHT

FOR SUSPENDED CEILING!

REG. 17.95

1288 IN CTN.

• Easily installed in any suspended grid ceiling with 2' x 4' openings

• Steel body with baked white enamel steel reflectors

• (Luminous panel and bulbs not included)

529 413/GL-240(0-1)

SAVE 5.07!



ornyte FIBERGLASS PANELS

WHITE OR GREEN

FIBERGLASS PANELS

- Add beauty and brightness to your home or garden
- Easy to install, needs no special tools or skills
- Shatterproof and safe, Ornyte is feather light, but strong and rigid - needs no special framing
- Weatherproof, never needs painting
- Will not warp, mildew or rot

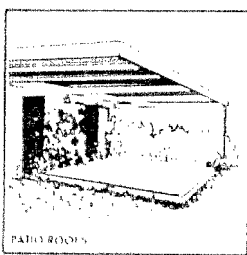

A5
GERBER

DECORATIVE 7 INCH LETTERS and NUMBERS
READY TO FINISH

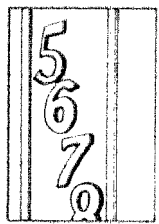

26 INCH x 8 FOOT

SALE PRICE **388**

Ornyte panels are designed for quick, simple installation. Instructions are simple and easy to follow. Save high labor costs by doing it yourself.

YOUR CHOICE
REG. 1.75

133
EACH

- Hundreds of uses - indoors or outdoors
 - Richly grained look - can be painted or stained
- 234 222/7000(1-25)



FREE
DO IT YOURSELF
BUILDING PLANS
AVAILABLE

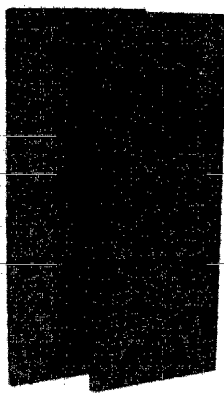
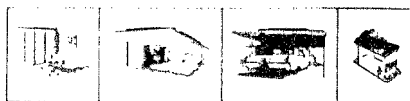

EMCO

WOODGRAINED EFFECT
BLACK POLYSTYRENE
SHUTTERS

15" x 39"
REG. 14.99 **888**

OTHER SIZES AVAILABLE

- High quality acrylic finish
 - Never need painting - just hose clean
 - Won't chip, warp, rot or peel
 - Authentic wood grained texture
- 162 941/PBL-39 16x39BLCK(1-5)

ALUMINUM SCREEN CLOSIN
New York
New York

DO IT YOURSELF AND SAVE

- Aluminum screen closes in many popular pre-cut sizes
- For doors and windows

18 INCH GARAGE BROOM
INCLUDES HANDLE
REG. 6.99 **433**

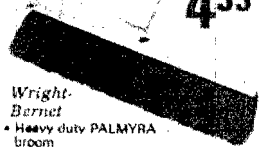

- Wright-Barnet
- Heavy duty PALMYRA broom
 - Heavy block
 - Includes 60" handle
- B23 604/8818(0-12)

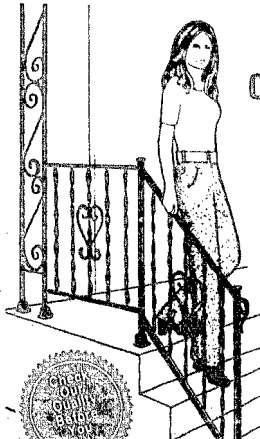

HWI

ORNAMENTAL IRON

4' RAIL SECTION SALE PRICE **466**
6' RAIL SECTION SALE PRICE **744**

- Ideal for either indoor or outdoor use - entrances, porches, balconies, room dividers
 - Easy to install; do-it-yourself
 - 1" x 1" square rail; hidden fittings eliminate drilling
- 118 553/429A(5-30)
118 562/430A(5-30)

WROUGHT IRON HARDWARE AVAILABLE

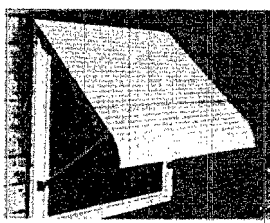

ALUMINUM AWNING

36 INCH REG. 22.50 **1588** IN CTN.
48 INCH REG. 28.50 **1988** IN CTN.

- All weather protection for door or window
 - Sturdy aluminum with easy-care baked enamel finish
- 285 787/84x36(0-1)
285 796/84x48(0-1)

Arcraft Industries

BLACK CITY MAILBOX
REG. 8.19 **547**



- Black enamel finish with elegant leaf mail slot
 - 8 1/2" W x 14 1/4" H x 3 1/2" D
- 230 592/4006(1-4)

GALVANIZED STEEL MAILBOX

REG. 6.19 **427**

- Ruggedly constructed rural mail box
 - Ribbed design with red tapered flag
 - 6 1/2" W x 8 3/4" H x 18" L
- 206 780/1-1(0-1)

Steel City Corp.

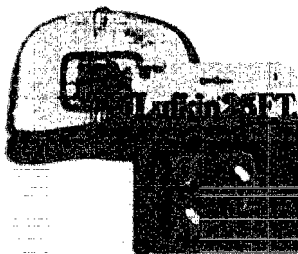

**FREE
CAP**

with purchase of
either

**16' POWER TAPE
OR
25' POWER TAPE**

Lufkin

- Buy a power tape and get a free cap!
- Easy to read, 1/4" easy coated blade, 16 ft or 25 ft.
- Excursion shock absorber minimizes tape breakage
- Lifetime case

312 744/Y16K(6 24) 312 751/Y25K(6 24)

16' POWER TAPE 25' POWER TAPE

REG. 9.79
688

REG. 10.49
788

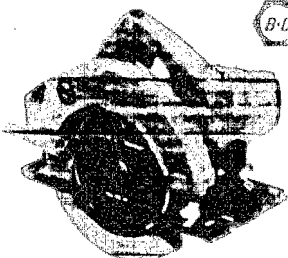

B-D Black & Decker
Best Buy
**7-1/4", 1-1/3 H.P.
CIRCULAR SAW**
2999*

- 1-1/3 HP. Double insulated
- Study wrap around shoe
- Two handle surfaces for steady control

355 911, 7339(0-1)

PROFESSIONAL MITRE BOX



WITH 4" x 24" 11 POINT BACKSAW

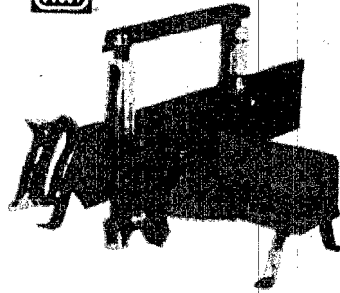

SALE PRICE

5688

- Eight adjustable steel saw guide rollers
- Easy-to-read scale
- 4" high steel legs
- Fully supports at all angles 300 720/HW10-1

12 POCKET CARPENTER APRON

REG. 13.98

997

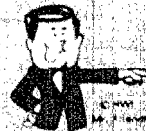

- Two large, heavy metal roll pockets, two more roll pockets and four small side tool pockets
- Strip leather hammer loop on right and left sides
- Heavy square holster and tape pocket
- New man-made "Durobit" urethane coated material with thick back and front of leather
- Strong and durable with up to 75% the wear strength of leather

McGuire-Nicholas

313 100, 1527(0-1)

REMINGTON
EXHAUSTER LOW VELOCITY
POWER HAMMER

REG. 29.95
2497

- Piles wood, metal in joints in 1/2" or less in 1/4" without drilling
- Includes starter
- Assembled at place - two tools

315-141-1
474K(1-1)
RES
PERMITS



Arrow
HEAVY DUTY
STAPLE GUN
TACKLER

REG. 10.95

1297



- Ideal tool for professional or home handy man
- Powerful - drives heavy gauge staples into hard woods, plywood, plastic

307 242, 750FS(1-12)

100 FOOT 16 GAUGE
GALVANIZED WIRE

REG. 2.29

144



- 16 gauge wire
- 100' on handy dispenser roll with wire cutter

435 731/1018(1-10)

LEATHER
TOOL/UTILITY
POUCH

REG. 5.99

397

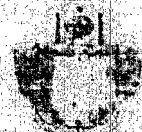

- Top grain cowhide
- One large center pocket, two flared front tool pockets and two open end, tapered side pockets

355 289, 405(0-1)
McGuire-Nicholas

FLAMMIA
7 PIECE
HOLE SAW SET

SIZES: 1-1/4", 1-1/2", 2", 2-1/8"

REG. 10.99

997



- Made from high quality 13mm hard and soft materials - fast wood, metal, plastic, light metal
- Available in regular, double box

312 824, 526(1-10)

Nicholson
26 INCH—3 POINT
HANDSAW

REG. 9.29

666

- Sturdy general purpose saw
- Flat ground blade
- Carved-grip handle

SAVE 2.63!

318 800/8008(0-2)

SOLDERING GUN KIT

- Complete kit for home and shop repairs, some electronics work
- Dural heat gun 170W & 125W
- Includes accessories

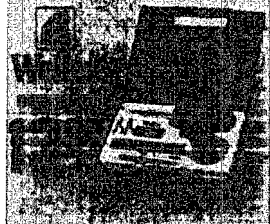

COUPON

Clip & Save

RAYO VAC

C or D SIZE
HEAVY DUTY

BATTERIES

YOUR CHOICE

PACKAGE OF 2

WITH
COUPON

49¢

• Sealed in steel
• Guaranteed against leakage
820 400 002M(0-96)
827 061 402M(0-96)

REG. 1.00

Additional or without coupon

59¢

HWI

ADVERTISING FOR NEWSPAPER
ADVERTISING SUPPLEMENT

SUPPLEMENT TO WAYNE HERALD
WAYNE, NE

HWI

BONUS

97¢

3-LITE-3 PANEL
SERVICE
DOOR

CHOICE OF
THREE SIZES

2'6" x 6'8" x 1-3/8"
2'8" x 6'8" x 1-3/8"
3'0" x 6'8" x 1-3/8"

- 1-3/8" select western wood
- Vinyl glazed for easy painting & impaling
- 1-8" tempered safety glass

160 567 2668(1-5) 160 536 2888(1-5)
160 603 3068(1-5)

Phenix Mfg Co.

PLASTIC
ROOF
CEMENT

SALE PRICE 57¢

- Forms waterproof seal
- Ideal for small jobs
- 1/10 gallon tube
- 103 685/5810-10

Overall

HWI

BONUS

Mobil
10W30 DETERGENCY
MOTOR OIL

59¢

QUART
IN CASE LOTS OF 24

- Premium heavy duty oil
- 570 408/10W30(0-24)



REG. 99¢

LESS THAN
FULL CASE
QUANTITIES
69¢ QUART

HWI

BONUS E-B

ALUMINUM
CLOTHESLINE
PROP

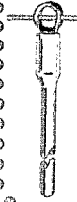

REG. 1.49

97¢

- 3/4" dia. x 7' long
- Spring steel clip grips line securely
- 917 363/PRSA(0-24)

SALE STARTS TODAY AND LASTS 10 BIG DAYS

CARHART LUMBER COMPANY

105 MAIN STREET

WAYNE, NE

PHONE: 375-2110

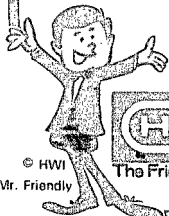

HWI
The Friendly Ones

© HWI
Mr. Friendly